

RM OF MACDONALD

ENVIRONMENT ACT PROPOSAL
WASTEWATER TREATMENT LAGOON
EXPANSION

COMMUNITY OF SANFORD

JUNE 2015



WASTEWATER TREATMENT LAGOON EXPANSION

COMMUNITY OF SANFORD

RM of Macdonald

Environment Act Proposal Report

Project No. 141-21811-00
Date: June 2015

—
WSP Canada Inc.
1600 Buffalo Place
Winnipeg, MB R3T 6B8 Canada

Phone: +1-204-477-6650
Fax: +1-204-474-2864
www.wspgroup.com





June 9, 2015

Ms. Tracey Braun, M.Sc.
Director, Environmental Approvals
MANITOBA CONSERVATION AND WATER STEWARDSHIP
160-123 Main Street
Winnipeg, MB R3C 1A5

**Subject : Environmental Act Proposal – R.M. of Macdonald – Community
of Sanford – Wastewater Treatment Lagoon Expansion**

Dear Ms. Braun,

The Rural Municipality of Macdonald – Community of Sanford has an existing two-cell wastewater stabilization pond operating under Environment Act Licence No. 857R dated October 12, 1979. Dictated by growth within the Community, the existing facility requires additional treatment and storage capacity. The major items of the proposed development are a new storage cell as well as converting the existing storage cell to a primary cell and converting the existing primary cell to a storage cell.

The enclosed Environment Act Proposal report (4 copies, 1 CD) provides the details and information of the proposed development. It is accompanied by the signed application form and a cheque in the amount of \$7,500.00. We request the opportunity to review the draft Environment Act Licence when it is issued. Please contact the undersigned if further information is required.

Regards,

Dana Bredin, P.Eng.
Geotechnical / Civil Engineer

WSP Canada Inc.
1600 Buffalo Place
Winnipeg, MB R3T 6B8 Canada

Phone: +1-204-477-6650
Fax: +1-204-474-2864
www.wspgroup.com

SIGNATURES

PREPARED BY



Dana Bredin, P.Eng.
Geotechnical / Civil Engineer

REVIEWED BY

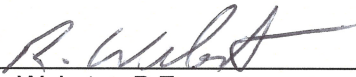

Ross Webster, P.Eng.
Manager, Environmental Group

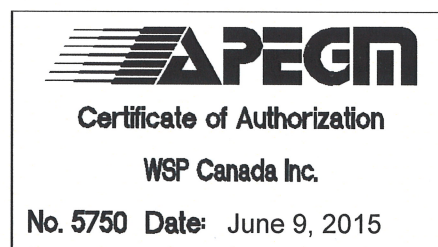

EXECUTIVE SUMMARY

Leading up to this Environment Act Proposal (EAP), WSP most recently completed a review of the community wastewater treatment capacity for the expansion of Sanford's wastewater treatment lagoon for the R.M. of Macdonald. With Council's agreement on a plan for expansion, the R.M. of Macdonald desired to move forward without delay to the preparation and submission of this EAP report.

The existing wastewater treatment lagoon is located south of the Community of Sanford and consists of one primary (treatment) cell and one secondary (storage) cell, receiving wastewater from a low pressure sewer collection system within the Community. Considering the existing capacities of the lagoon and the anticipated growth within Sanford, expansion of the existing wastewater facility is required.

The expansion was not designed on the basis of a 20 year projection, but rather on reconfiguring the existing cells and adding additional storage capacity by utilizing the available land, which will provide approximately 23 years of growth. This will also allow room for some expansion of the existing waste disposal grounds to the south of the lagoon.

The proposed development involves the construction of one new cell to increase the storage capacity of the lagoon facility with a 1 metre clay liner, as well as converting the existing storage cell to become a larger primary cell and the existing primary cell to become a smaller secondary cell. The expanded facility will maintain the existing discharge route from the new and reconfigured secondary cells into the Wheatland Drain and eventually the La Salle River. The planned seasonal discharge period will be from June 15 through to November 1, with expected late spring and fall discharges.

Upon approval from Manitoba Conservation and Water Stewardship and the issuance of an Environment licence, it is anticipated that the tender and construction will begin in the spring/summer of 2016.

TABLE OF CONTENTS

1	DEVELOPMENT INFORMATION.....	1
1.1	CANADIAN ENVIRONMENTAL ASSESSMENT INFORMATION.....	2
2	DESCRIPTION OF DEVELOPMENT	3
2.1	LEGAL DESCRIPTION AND OWNERSHIP.....	3
2.2	MINERAL RIGHTS.....	3
2.3	DESCRIPTION OF EXISTING LAND USE.....	4
2.4	PREVIOUS STUDIES.....	4
3	EXISTING WASTEWATER TREATMENT LAGOON.....	5
3.1	DESCRIPTION	5
3.2	EXISTING CAPACITY.....	5
3.2.1	TREATMENT CAPACITY.....	5
3.2.2	STORAGE CAPACITY	6
3.3	DISCHARGE ROUTE.....	6
4	POPULATION SERVICED AND DESIGN LOADING	8
4.1	SOURCES OF WASTEWATER.....	8
4.2	POPULATION	8
4.3	ORGANIC LOADING	8
4.4	HYDRAULIC LOADING	8
5	PROPOSED DEVELOPMENT.....	11
5.1	SITE CONDITIONS	11
5.1.1	LOCAL TOPOGRAPHY.....	11
5.1.2	SOIL CONDITIONS	11
5.1.3	GROUNDWATER.....	12
5.1.4	SITE INVESTIGATION	12
5.2	DESCRIPTION OF PROPOSED DEVELOPMENT	12
5.2.1	NEW SECONDARY CELL.....	12

5.2.2	CONVERTED PRIMARY AND SECONDARY CELLS	13
5.2.3	EFFLUENT QUALITY	15
5.2.4	SUMMARY.....	15
5.2.5	CONSTRUCTION DETAILS.....	16
6	ENVIRONMENTAL IMPACTS.....	17
6.1	ODOUR CONSIDERATIONS.....	17
6.2	LAND IMPACT	17
6.3	SURFACE WATER	17
6.3.1	FUEL STORAGE ON SITE.....	17
6.4	GROUNDWATER.....	18
6.5	SPECIES IMPACT	18
6.6	FISHERIES	18
6.6.1	FISHERIES ACT INFORMATION	18
6.7	FORESTRY	18
6.8	HERITAGE RESOURCES	19
6.9	SOCIO-ECONOMIC IMPACTS.....	19
6.10	PUBLIC INVOLVEMENT	19
7	MANAGEMENT PRACTICE.....	20
7.1	OPERATION.....	20
7.1.1	DISCHARGE.....	20
7.1.2	MAINTENANCE, RECORD KEEPING AND INSPECTION	20
8	SCHEDULE AND FUNDING	22
9	REFERENCES.....	23

TABLES

TABLE 1.1	PROPOSAL CONTENTS
TABLE 1.2	CEAA PROPOSAL CONTENTS
TABLE 3.1	EXISTING PRIMARY CELL PARAMETERS
TABLE 3.2	EXISTING SECONDARY CELL PARAMETERS
TABLE 5.1	PRELIMINARY DESIGN SPECIFICATIONS FOR THE NEW SECONDARY CELL
TABLE 5.2	PRELIMINARY DESIGN SPECIFICATIONS FOR THE RECONFIGURED PRIMARY CELL
TABLE 5.3	PRELIMINARY DESIGN SPECIFICATIONS FOR THE RECONFIGURED SECONDARY CELL
TABLE 5.4	EXPANDED WASTEWATER TREATMENT LAGOON CAPACITIES

FIGURES

FIGURE 2.1	LOCATION MAP OF THE EXISTING AND PROPOSED DEVELOPMENT
FIGURE 3.1	EFFLUENT DISCHARGE ROUTE FROM THE SANFORD LAGOON
FIGURE 4.1	TOTAL MONTHLY WASTEWATER VOLUME
FIGURE 4.2	CUMULATIVE WASTEWATER VOLUME – WINTER STORAGE PERIOD
FIGURE 8.1	SCHEDULE - EAP SUBMISSION TO END OF CONSTRUCTION

APPENDICES

APPENDIX A	STATUS OF TITLE
APPENDIX B	EXISTING ENVIRONMENT ACT LICENCE
APPENDIX C	GEOTECHNICAL REPORT
APPENDIX D	PLANS AND DETAILS
APPENDIX E	GENERAL CORRESPONDENCE FOR REFERENCE

1 DEVELOPMENT INFORMATION

R.M. of Macdonald – Community of Sanford – Wastewater Treatment Lagoon Expansion

Name of development

R.M. of Macdonald

Legal name of the proponent of the development

NW ¼ Sec. 17 Twp. 8 Rge. 1 E.P.M.

Location of development

Contact Person for Proponent:

Mr. Tom Raine
Chief Administrative Officer
R.M. of Macdonald
Box 100, 161 Mandan Drive
Sanford, MB, R0G 2J0

Contact Person for Environmental Assessment:

Mr. Dana Bredin, P.Eng.
WSP
1600 Buffalo Place
Winnipeg, MB R3T 6B8

TABLE 1.1: PROPOSAL CONTENTS

Section of Environmental Act Proposal Form		Section Number in Report
DESCRIPTION OF DEVELOPMENT:		
(i)	Legal description and map of development	2.1
(ii)	Mineral rights	2.2
(iii)	Existing land use	2.3
(iv)	Land use designation	2.3
(v)	Previous studies	2.4
(vi)	Proposed development	5.0
(vii)	Storage of gasoline or associated products	6.3.1
(viii)	Potential impacts	6.0
(ix)	Proposed environmental management	7.0
SCHEDULE:		8.0
FUNDING:		8.0

1.1 CANADIAN ENVIRONMENTAL ASSESSMENT INFORMATION

TABLE 1.2: CEAA PROPOSAL CONTENTS

Screening Report Outline		Section Number in Report
1.	Assessment Responsibility - Funding	8.0
2.	Project Description	
	2.1 General	2.0, 4.0, 5.0
	2.2 Project Components	5.2
	2.3 Construction Details	5.2.5
	2.4 Project Scoping	4.0
3.	Description of Environment	
	3.1 Land Uses and Ownership	2.1, 2.2, 2.3
	3.2 Local Soils, Topography, Geology	5.1
	3.3 Hydrology / Hydrogeology	6.3, 6.4
	3.4 Vegetation Communities	6.5
	3.5 Fish, Wildlife, and Habitat	6.5, 6.6, 6.7
	3.6 Endangered or Threatened Species	6.5
	3.7 Historic and Cultural Sites	6.8
4.	Environmental Impacts and Mitigation	
	4.1 Water Quality	6.3
	4.2 Odour	6.1
	4.3 Fisheries	6.3, 6.6
	4.4 Wetland / Wildlife Habitat	6.3
	4.5 Soils and Vegetation	6.2, 6.5
	4.6 Heritage Resources	6.8
	4.7 Navigable Waters	6.3
5.	Cumulative Effects	6.0
6.	Public Involvement	6.10
7.	Follow-Up	7.0
8.	Contacts	1.0
9.	Personal Communication	Appendix E
10.	Attachments	Appendix A, B, C, D, E

2 DESCRIPTION OF DEVELOPMENT

2.1 LEGAL DESCRIPTION AND OWNERSHIP

The existing wastewater treatment lagoon is located on a northern portion of the NW ¼ 17-8-1 EPM. The R.M. of Macdonald is the registered owner of the existing lagoon land, as identified in Status of Title No.1289566. Specifically, this area of ownership is Public Works Plan 15508 Winnipeg Land Titles Office (WLTO), in NW ¼ 17-8-1 EPM.

The new development is to be located on the available land adjacent to the existing lagoon facility on the east side within NW ¼ 17-8-1 EPM, as shown in Figure 2.1. According to Status of Title No. 1289566, the R.M. of Macdonald is the registered owner of the land proposed for development. The aforementioned Status of Title is included in Appendix A.

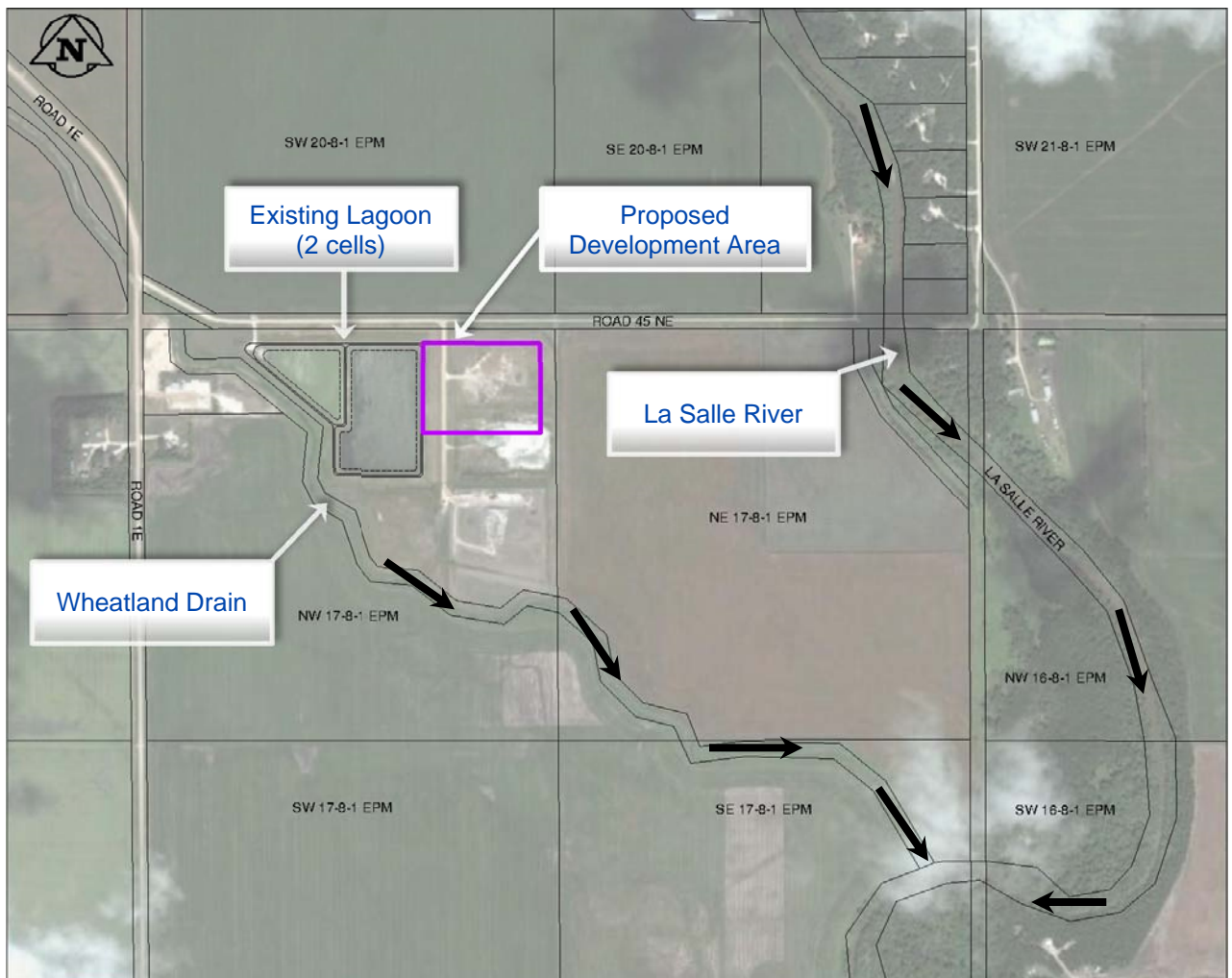

FIGURE 2.1: LOCATION MAP OF THE EXISTING AND PROPOSED DEVELOPMENT

2.2 MINERAL RIGHTS

The Crown Lands and Property Agency – Lands Branch was contacted to provide information on the mines & minerals and sand & gravel ownership of the applicable lands discussed in the previous section. The

Province acquired Public Plan 15508 WLTO in NW ¼ 17-8-1 EPM and has ownership of the mines and minerals, and sand and gravel. Correspondence is included in Appendix E.

2.3 DESCRIPTION OF EXISTING LAND USE

Through information provided by the R.M. of Macdonald, the existing lagoon land and the land intended for lagoon development are designated as an “Environmental Policy Area” and zoned “EV – Environmental Policy Area”. Bylaw Map Four for the Macdonald-Richot Planning District illustrating the land zoning is included in Appendix E.

The existing lagoon is surrounded by agricultural land and is bordered on the south and east by an existing landfill for household waste and two former remediation soil treatment cells owned by the R.M. of Macdonald. To the west of the lagoon is the Wheatland Drain, where the lagoon is currently discharging into.

The expanded lagoon will occupy land that was previously used as soil treatment facility for the treatment of petroleum hydrocarbon impacted soils. It is understood that approximately 5,500 m³ of contaminated soil was deposited and treated since 2013 and reworked/turned during 2014. Stantec was retained by the R.M. of Macdonald to conduct sampling, testing and analysis of the contaminated soils. Stantec has recommended that the R.M. of Macdonald apply to Manitoba Conservation and Water Stewardship for approval to use the soil as waste or cover material at the adjacent landfill.

2.4 PREVIOUS STUDIES

2015 ***Geotechnical Report: “Proposed R.M. of Macdonald – Community of Sanford WWSP Expansion” prepared by WSP for the R.M. of Macdonald***

→ This report provides a detailed geotechnical investigation of the proposed development site conducted by WSP on January 5, 2015. The investigation included testhole drilling, sample collection and laboratory testing. The report concluded that based on soil conditions, the proposed expansion should be constructed with a 1 m clay liner utilizing the underlying high plasticity clay.

2015 ***“Soil Sampling Program at the Sanford Soil Treatment Facility, Rural Municipality of Macdonald, Manitoba” prepared by Stantec for the R.M. of Macdonald***

→ This report provides a summary of the sampling and testing of the soil at the Sanford Soil Treatment Facility prepared by Stantec on April 10, 2015. For the approximate 5,500 m³ of soil present at the Site, eighteen soil samples were analyzed for BTEX and PHC Fraction F1-F4. Only nine of the eighteen samples tested for PHC Fraction F2 that ranged from 1.5 to 6.2 times the CCME guideline of 260 mg/kg. It was recommended that R.M. of Macdonald apply to Manitoba Conservation at Water Stewardship that soil be used as waste or cover material at the adjacent waste disposal grounds.

2009 ***“Macdonald-Richot Planning District – Background Engineering Study” prepared by GENIVAR for the Macdonald-Richot Planning District***

→ This report identifies the design capacity of the primary and secondary cells for the Sanford Lagoon. As of February 2009, the primary cell was at approximately 65% of its organic capacity and the secondary cell is at approximately 90% of its 227-day storage period.

3 EXISTING WASTEWATER TREATMENT LAGOON

3.1 DESCRIPTION

The existing licence directing lagoon operation is Environment Act Licence No. 857R, dated October 12, 1979. The lagoon was constructed at this time. The licence is attached in Appendix B.

The existing wastewater treatment lagoon is approximately 1.5 kilometres south of Sanford and 1 kilometre south of Provincial Trunk Highway 3. The lagoon serves the Community of Sanford and it was constructed and commissioned in 1980. It consists of one primary cell and one secondary cell. The lagoon is connected to the low pressure sewer system via a lift station and forcemain. This lagoon does not receive truck-hauled septage or wastewater. The Oak Bluff lagoon is the designated municipal lagoon to receive outside truck hauled wastewater and septage. Discharge of treated effluent is by ditch into the Wheatland Drain southwest of the lagoon which subsequently flows southeast intersecting with the La Salle River approximately 1.4 kilometres southeast of the lagoon.

3.2 EXISTING CAPACITY

The existing Sanford lagoon has one primary treatment cell and one secondary storage cell that collectively function in the treatment and storage of the wastewater. Information regarding the actual dimensions and elevations of the existing lagoon was based on the “Sanford Sewer Services Project – Sections and Details for Proposed Sewage Lagoon” as well as data from a 2014 WSP topographic survey.

The ability of a lagoon to treat the incoming wastewater is a measure of organic loading capacity. Organic loading refers to the quantity of organic material present in the incoming wastewater and is measured as the five day Biochemical Oxygen Demand (BOD₅). The organic loading becomes the total mass of BOD₅ in kg/d in the wastewater discharged to the lagoon. The wastewater from piped serviced areas are consistent on a year-round basis and do not have a seasonal variation.

The ability of a lagoon to store the incoming wastewater is a measure of its hydraulic loading capacity. Hydraulic loading refers to the volume of sewage flow to the lagoon. Wastewater treatment lagoons are presently designed for a 227-day storage period beginning November 1st and ending June 15th of the following year. Hydraulic loading over the 227-day storage period is used to calculate the volume of storage required in the lagoon facility.

3.2.1 TREATMENT CAPACITY

Most lagoons in the Province of Manitoba, including the Sanford lagoon, have conventional facultative primary treatment cells. Justification for the selection of conventional primary cells is found in the availability of land at the site, lack of any high strength wastewater to treat, as well as the limited costs associated with an acceptable amount of treatment that conventional primary cells provide.

According to the Manitoba Conservation guideline, a primary treatment cell requires one hectare of liquid surface area per 56 kg-BOD₅/day loading. The existing primary cell has a surface area of approximately 1.47 ha at a liquid level of 1.5 m and on this basis, can service a daily organic loading of **82.3 kg-BOD₅**.

Table 3.1 lists the relevant information concerning the existing primary cell, determined from the “Sanford Sewer Services Project – Sections and Details for Proposed Sewage Lagoon” as well as the 2014 WSP topographic survey. Since Manitoba Conservation stipulates that only half of the total volume for primary cells contributes to the hydraulic storage of the lagoon, the storage volume of the existing primary cell is simply half of its total volume.

TABLE 3.1: EXISTING PRIMARY CELL PARAMETERS

Parameter	Primary Cell
Cell Bottom Dimensions	Irregular
Liquid Surface Dimensions (at operating depth)	Irregular
Operating Depth	1.5 m
Freeboard Height	1.0 m
Interior Side Slope	4 H : 1 V
Total Volume (at operating depth)	19,700 m ³
Storage Volume (½ of total volume)	9,850 m ³
Liner System	Clay Liner

3.2.2 STORAGE CAPACITY

Presently, the existing secondary cell has a storage capacity of approximately 40,700 m³. Calculating the storage capacity is done under the assumption that the bottom 0.3 m of liquid depth is considered “dead” storage, thus the storage volume is the total volume less the “dead” storage volume. Adding the storage capacity of the primary cell, as listed in Table 3.1, the total storage capacity of the lagoon facility is 50,500 m³.

Table 3.2 lists the relevant information concerning the existing secondary cell.

TABLE 3.2: EXISTING SECONDARY CELL PARAMETERS

Parameter	Secondary Cell
Cell Bottom Dimensions	127 m - 152 m x 235 m
Liquid Surface Dimensions (at operating depth)	139 m - 164 m x 247 m
Operating Depth	1.5 m
Freeboard Height	1.0 m
Interior Side Slope	4 H : 1 V
Total Volume (at operating depth)	50,200 m ³
Deadspace Volume (bottom 0.3 m of liquid depth)	9,500 m ³
Storage Volume (total volume - deadspace volume)	40,700 m ³
Liner System	Clay Liner

3.3 DISCHARGE ROUTE

The lagoon secondary cells are typically discharged over the course of the allowable discharge period from June 15 to October 31. The effluent is discharged via a 250 mm diameter pipe from the existing secondary cell into the Wheatland Drain which flows southeast before discharging into the La Salle River. The distance from the discharge point into the Wheatland Drain to the La Salle River is approximately 1.4 km. The discharge route is illustrated in Figure 3.1.

The existing and proposed lagoon facility is in the Lower La Salle River Watershed (No. 22).

FIGURE 3.1: EFFLUENT DISCHARGE ROUTE FROM THE SANFORD LAGOON

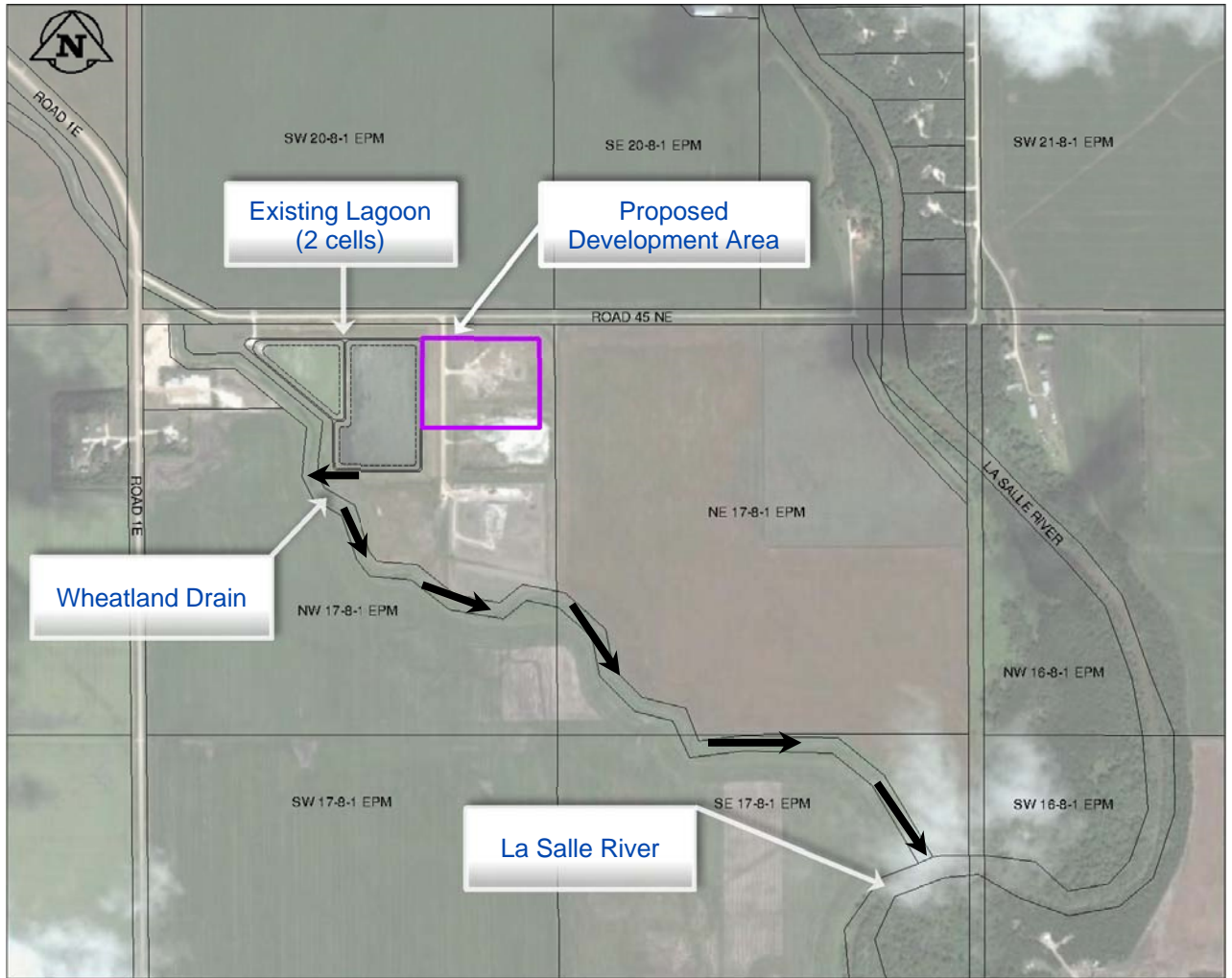

4 POPULATION SERVICED AND DESIGN LOADING

4.1 SOURCES OF WASTEWATER

The existing Sanford lagoon services only the domestic wastewater from the Community of Sanford. There are no significant industrial or high strength contributors. No outside truck-hauled wastewater is received at the Sanford lagoon. Truck-hauled wastewater generated within the municipality is directed towards the Oak Bluff lagoon.

4.2 POPULATION

Statistics Canada 2011 census data shows the population for the Community of Sanford to be 852. The current (2015) population of the Community of Sanford is approximately **852 people**, according to information provided by the R.M. of Macdonald.

In addition to the serviced residents, the Community sewer system serves **378 bussed-in students**. Typically in calculating wastewater flow we use a ratio of 3:1 (3 bussed-in students are equivalent to 1 person in a dwelling). However, the R.M. of Macdonald is in the Capital Region and it is well established that there is a daily commute of people that travel into the City of Winnipeg. Therefore, the commuter dynamic cancels out of the impact of the bussed-in-students. As a result, the **total equivalent population is 852**.

To project the future population of Sanford, an assumption of 10 new dwellings per year was applied to the current number of persons per dwelling. According to the 2011 Census data, Sanford has a population of 852 and there are 321 occupied dwellings. Thus, the number of persons per dwelling is approximately 2.65. Assuming 10 new dwellings per year with 2.65 persons per dwelling, the Community of Sanford is projected to have a population of 1,513 by 2040, not including bused-in students.

4.3 ORGANIC LOADING

As defined in Section 3.2, organic loading refers to the quantity of organic material present in the incoming wastewater and is measured as the five day Biochemical Oxygen Demand (BOD₅). The wastewater from the piped serviced areas are consistent on a year-round basis and do not have a seasonal variation.

On the basis of accepted practice, the daily BOD₅ production for domestic wastewater collected via a piped system is 0.077 kg per person. With a current (2015) equivalent population of 852, the organic loading to the existing Sanford lagoon is **65.6 kg-BOD₅/d**.

As stated in Section 3.2, the existing primary cell of the lagoon provide an organic loading capacity of 82.3 kg-BOD₅/d.

Therefore, the existing primary cell is operating at 80% capacity and would have adequate treatment capacity for the present and future loadings, up to a population of 1,068 people.

Outside septic and/or holding tank loading need not be considered for this lagoon, as previously stated in Section 4.1.

4.4 HYDRAULIC LOADING

As defined in Section 3.2, hydraulic loading refers to the volume of sewage flow to the lagoon. Wastewater facilities are presently designed for a 227-day storage period beginning November 1st and ending June 15th

of the following year. Hydraulic loading over the 227-day storage period is used to calculate the volume of storage required in the lagoon facility.

The existing lift station that receives the wastewater collected in the Community is a precast below-ground facility built in 2003. There are two submersible Flygt 18 hp units.

WSP has reviewed in detail the wastewater flow data from the existing lift station obtained from the R.M. of Macdonald for the period of January 2011 to April 2015. Based on the reviewed data, the yearly wastewater generation for the Community was calculated at between 183 and 201 litres per capita per day (Lpcd), which included infiltration. This corresponds to an average of 191 Lpcd. The following Figure 4.1 shows the total monthly wastewater volume per year.

FIGURE 4.1: TOTAL MONTHLY WASTEWATER VOLUME

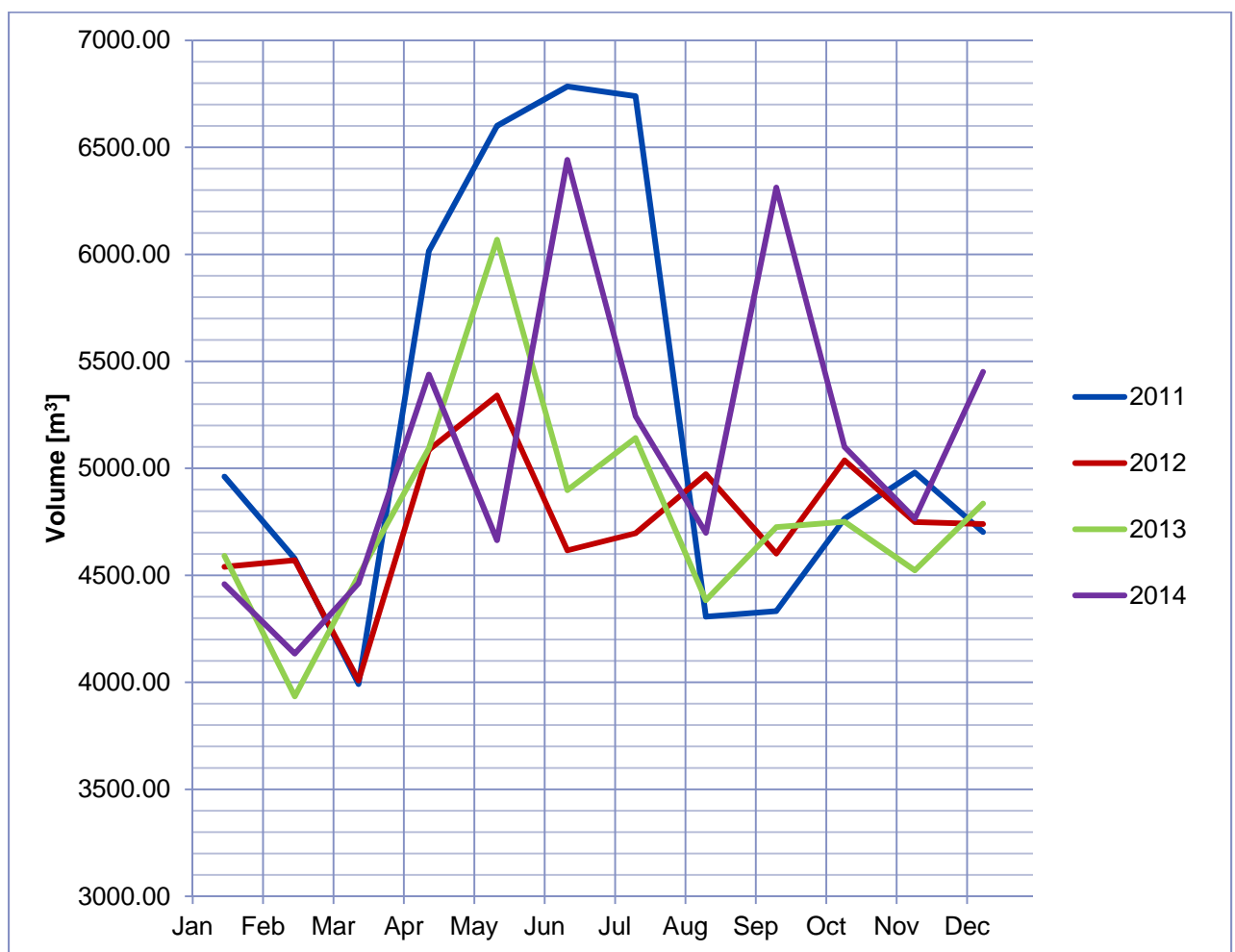

The wastewater flow data was further subdivided into the total amount of wastewater per winter storage period, November 1 until June 15. From the data provided, the total amount of wastewater generated from the three previous winter storage periods was calculated to be between 35,182 m³ and 36,123 m³. This corresponds to an average of 185 Lpcd. The following Figure 4.2 shows the cumulative wastewater volume for the winter storage period since November 1, 2011.

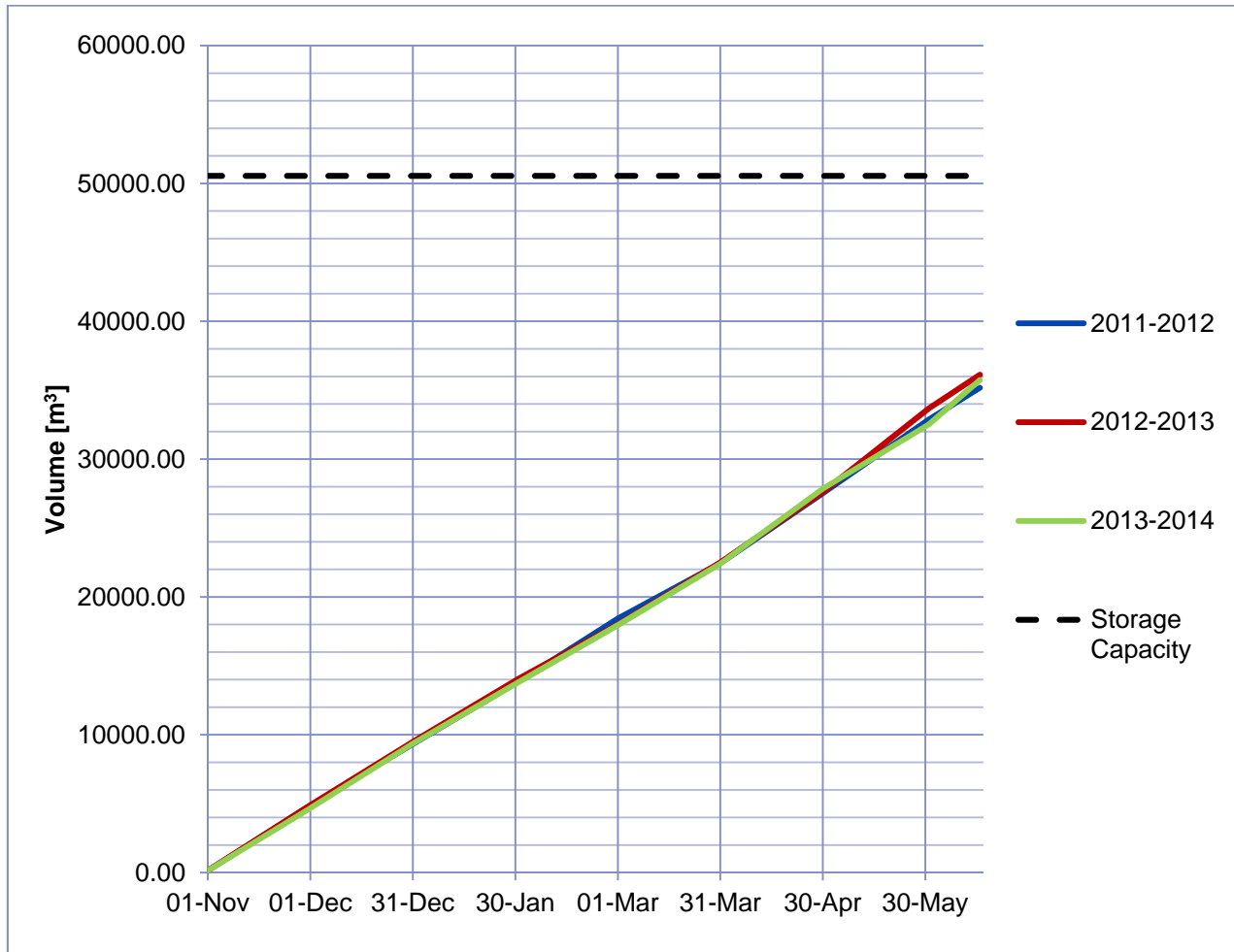
FIGURE 4.2: CUMULATIVE WASTEWATER VOLUME – WINTER STORAGE PERIOD

Based on this data, the Community of Sanford is utilizing approximately 71-72% of its existing storage capacity over the 227-day winter storage period.

Even though this wastewater generation appears low, it can be justified when considering that Sanford is a satellite community to the City of Winnipeg. Most of the population works in Winnipeg and the Community is mainly residential in nature. It is understood that the design guideline for the R.M. of Macdonald specify designing for 325 Lpcd, which in this case would amount to a 70% increase in wastewater generation. However, for the purposes of this proposal, a prudent approach would suggest designing for **215 Lpcd**.

Applying the design rate of 215 Lpcd and the current population of 852, the design hydraulic loading to the existing Sanford lagoon is **41,541 m³**.

As stated in Section 3.2, the lagoon provides a hydraulic loading capacity of 50,550 m³.

Thus, using the design rate of 215 Lpcd, the existing lagoon is using 82% of its storage capacity and has adequate storage capacity for the present and future hydraulic loadings of up to a population of 1,113 people.

Outside septic and/or holding tank loading need not be considered for this lagoon, as previously stated in Section 4.1.

5 PROPOSED DEVELOPMENT

Rather than sizing the expanded lagoon for a 20-year life, the proposed expansion involves utilizing the current lagoon and the land available to provide wastewater treatment for population of up to 1,500, which corresponds to approximately 23 years of service.

The proposed development consists of:

- new secondary cell
- convert the existing secondary cell to a primary cell
- convert the existing primary cell to secondary cell
- piping, valves, fencing, signage

The EAP design drawings are appended (Appendix D). The expansion work is to be completed while the facility remains in operation.

The expanded lagoon will provide adequate treatment for a population of approximately 2,636 people and storage for a population of approximately 1,460 people.

5.1 SITE CONDITIONS

On January 5, 2015 WSP conducted a geotechnical investigation at the proposed development area during which a drill rig was used to drill a total of 6 testholes (TH1 to TH6) between 4.6 m and 7.6 m depths below grade. The complete Geotechnical Report is included in Appendix C.

5.1.1 LOCAL TOPOGRAPHY

The proposed site is located on an area known as the Red River Plain sub-area. The Red River Plain sub-area is a clay basin, with local flood plains and river levees, which occupies the flat areas in the lower-lying part of the Lake Agassiz basin. The area consists of lacustrine clay and alluvial deposits which range from a few metres to 13 m or more in thickness. Limestone bedrock below thick clay and till layers (see the attached nearest well log of NW 19-8-1 EPM) underlies much of the surficial deposits about 20 m below grade.

5.1.2 SOIL CONDITIONS

The general soil profile reveals a topsoil/fill layer of about 100 mm to 2400 mm followed by a thick clay layer, which extended to the bottom of each testhole, 7.6 m below grade. High plasticity clay was observed down beneath the topsoil/fill layer.

As discussed in Section 2.3, the new secondary cell will be constructed on land previously used as a soil treatment facility. One testhole (TH6) was drilled within this treatment facility where the new cell will be situated. The testhole revealed a layer of fill, 1200 mm thick. As per information provided by the R.M. of Macdonald, the thickness of the treated soil is approximately 450 mm. The thickness of the treated soil was spread as uniformly as possible to properly treat the soil, thus large deviations in the thickness of the treated soil is unlikely. The remaining portion of fill is most likely surplus material stockpiled from the previous construction of the existing lagoon or waste disposal grounds.

No seepage and caving conditions were observed from the testholes. A detailed description of the soil profile is presented in the attached logs, Appendix C (Geotechnical Report).

5.1.3 GROUNDWATER

Presently, there is a preliminary groundwater report prepared by the Planning Branch of the Water Resources Division for this area. Groundwater is readily available but only fresh in the areas east of the Red and Rat Rivers. The main aquifer in the area is the carbonate bedrock (limestone and dolostone) that underlies the entire area but bears freshwater only in the area east of the Red and Rat Rivers. The depth to the carbonate bedrock ranges from 12 m to 40 m. Minor shallow sand aquifers were found along the La Salle River meander belt and along one of its tributaries near Starbuck. The well yields of the main aquifer are adequate for moderate industrial and municipal requirements and groundwater quality ranges from fair to excellent.

A review of the Groundwater Pollution Hazard Map shows that the property is located outside a groundwater pollution hazard area.

Based on the drainage map of the area, groundwater flow at the site is immediately towards the east and eventually heading to the La Salle River.

5.1.4 SITE INVESTIGATION

As classified during the field investigation, the clay layer encountered at the site was visually classified as high plasticity clay beneath the topsoil/fill layer. Due to this reason, hydraulic conductivity of the in-situ clay at approximately 1.5 m (TH5) was tested.

The clay material of the upper 1.5 m depths is a CH material based on visual classification. The estimated hydraulic conductivity of this material should range between 10^{-8} to 10^{-9} cm/sec.

The hydraulic conductivity of the in-situ clay obtained at 1.5 m depth for TH5 was 2.0×10^{-8} cm/sec.

5.2 DESCRIPTION OF PROPOSED DEVELOPMENT

The following sections describe the construction and modifications proposed for the development. No changes are proposed for the existing wastewater collection system or the lift stations within the Community of Sanford.

The lagoon cell construction is based on the information and recommendations provided in the 2015 Geotechnical Report. Organic soil from the new lagoon cell area to be developed will be stockpiled and reapplied at the end of construction on the applicable disturbed areas and on the dykes as shown in the drawings. The treated soil in the former north soil treatment cell will be stripped from the site where the new lagoon cell will be constructed and used for fill or cover in the waste disposal ground. The area will be stripped at a depth of 600 mm to ensure all treated soil is removed prior to construction of the new cell.

For disturbed areas where sediment or erosion control is deemed necessary, the contractor will be required to employ appropriate measures.

5.2.1 NEW SECONDARY CELL

The new secondary cell will be constructed as illustrated in the EAP design drawings (Appendix D) and will be located to the east of the existing secondary cell and north of the existing landfill.

The new cell is designed with a 1.0 m (min.) wide surface clay liner extending around the interior slopes of the new dykes. The clay liner, shall have a permeability of 1×10^{-7} cm/s or less, meeting the Manitoba Conservation and Water Stewardship (CWS) guidelines. The remainder of the dykes will be constructed with in-situ material. All embankments will be constructed in 150 mm lifts compacted to 95% Standard Proctor Dry Density.

The new cell will be constructed with 4:1 interior side slopes and 4:1 exterior side slopes and will have a normal operating depth of 1.5 metres with a minimum 1.0 metre freeboard. The interior dykes will be armoured with rip rap to prevent erosion. Table 5.1 provides the details for the preliminary design specifications for the New Secondary Cell.

Perimeter ditching will be maintained and extended around the new cell, as required.

TABLE 5.1: PRELIMINARY DESIGN SPECIFICATIONS FOR THE NEW SECONDARY CELL

Parameter	New Secondary Cell
Cell Bottom Dimensions	207.0 X 110.0 m
Liquid Surface Dimensions (at operating depth)	219.0 X 122.0 m
Top of Dyke (inside to inside)	227.0 X 130.0 m
Operating Depth	1.5 m
Freeboard Height	1.0 m
Interior Side Slope	4 H : 1 V
Exterior Side Slope	4 H : 1 V
Total volume (at operating depth)	37,000 m ³
Dead storage volume (at 0.3 m depth)	6,935 m ³
Storage Volume	30,065 m ³
Liner system	1 m Clay Liner

5.2.2 CONVERTED PRIMARY AND SECONDARY CELLS

The existing secondary cell and primary cell will be converted as illustrated in the design drawings (Appendix D). The existing primary cell will become a new secondary cell and the existing secondary cell will become a new primary cell. The 150 mm forcemain will be extended into the new primary cell and a new discharge pipe will be added to the new secondary cell. Table 5.2 and 5.3 provide the details for the preliminary design specifications for the reconfigured primary and secondary cells.

TABLE 5.2: PRELIMINARY DESIGN SPECIFICATIONS FOR THE CONVERTED PRIMARY CELL

Parameter	Reconfigured Primary Cell
Cell Bottom Dimensions	127.0 – 152.0 x 235.0 m
Liquid Surface Dimensions (at operating depth)	139.0 – 164.0 x 247.0 m
Top of Dyke (inside to inside)	147.0 – 172.0 x 255.0 m
Operating Depth	1.5 m
Freeboard Height	1.0 m
Interior Side Slope	4 H : 1 V
Exterior side slope	4 H : 1 V
Total volume (at operating depth)	50,200 m ³
Dead storage volume (at 0.3 m depth)	--
Storage volume	25,100 m ³
Liner system	Clay Liner

TABLE 5.3: PRELIMINARY DESIGN SPECIFICATIONS FOR THE CONVERTED SECONDARY CELL

Parameter	Reconfigured Secondary Cell
Cell Bottom Dimensions	Irregular
Liquid Surface Dimensions (at operating depth)	Irregular
Top of Dyke (inside to inside)	Irregular
Operating Depth	1.5 m
Freeboard Height	1.0 m
Interior Side Slope	4 H : 1 V
Exterior side slope	4 H : 1 V
Total volume (at operating depth)	19,700 m ³
Dead storage volume (at 0.3 m depth)	3,575 m ³
Storage volume	16,125 m ³
Liner system	Clay Liner

5.2.3 EFFLUENT QUALITY

To date, there have been no uncommon issues in the RM of MacDonald's ability to meet the discharge requirements of their existing Environment Act Licence. We anticipate a 1.0 mg/L phosphorus limit to be applied to the facility.

According to the Federal Wastewater Systems Effluent Regulations (WSER), the Sanford wastewater treatment lagoon is considered an *Intermittent Wastewater System* as it has a hydraulic retention of at least 90 days discharging at most four periods per calendar year.

This type of wastewater system treatment lagoon must manage the release of the following deleterious substances:

- (a) carbonaceous biochemical oxygen demanding matter;
- (b) suspended solids;
- (c) total residual chlorine; and
- (d) un-ionized ammonia.

The discharge of treated effluent must comply with the following conditions:

- (a) the average carbonaceous biochemical oxygen demand due to the quantity of CBOD matter in the effluent does not exceed 25 mg/L;
- (b) the average concentration of suspended solids in the effluent does not exceed 25 mg/L;
- (c) the average concentration of total residual chlorine in the effluent does not exceed 0.02 mg/L, if chlorine, or one of its compounds, is used in the treatment of wastewater; and
- (d) the maximum concentration of un-ionized ammonia in the effluent does not exceed than 1.25 mg/L, expressed as nitrogen (N), at $15^{\circ}\text{C} \pm 1^{\circ}\text{C}$.

These parameters already appear in presently issued Environment Act Licences, bringing greater order and unity to the Provincial and Federal standards. WSER also calls for acute lethality testing on the discharging treated effluent, with the sampling frequency dependent on the annual average daily volume.

The effluent quality will also be restricted to a fecal coliform limit, as indicated by the MPN index, of 200 per 100 mL.

There is little concern that a well maintained lagoon system will have issues with meeting any of these conditions, with the exception of the phosphorus limit. With the use of alum or ferric to precipitate the phosphorus, the effluent quality is expected to meet all federal and provincial requirements.

5.2.4 SUMMARY

After expansion, the Sanford lagoon will be a three-cell lagoon. One primary cell will provide adequate treatment for a population of approximately 2,636 people, while the storage capacity of the system will provide storage (215 Lpcd, 227 days) for a population of approximately 1,460 people. Table 5.4 summarizes the expanded lagoon capacities.

TABLE 5.4: EXPANDED WASTEWATER TREATMENT LAGOON CAPACITIES

Cell Type	Liquid Surface Area [ha]	Total Volume [m ³]	Dead Storage Volume [m ³]	Storage Volume [m ³]
Primary Cell 1 (reconfigured cell)	3.625	50,200	--	25,100
Secondary Cell 1 (reconfigured cell)	--	19,700	3,575	16,125
Secondary Cell 2 (new cell)	--	37,000	6,935	30,065
Total	3.625	106,900	10,510	71,290

5.2.5 CONSTRUCTION DETAILS

According to the subsurface profiles in the 2015 Geotechnical Report, the depth of topsoil in the proposed area was approximately 100 mm - 150 mm. Organic soil from the lagoon area will be stockpiled and reapplied at the end of construction on the applicable disturbed areas and on the dykes as shown in the drawings.

The treated soil in the former north soil treatment cell will be stripped from the site where the new lagoon cell will be constructed and used for fill or cover in the waste disposal ground. The area will be stripped at a depth of 600 mm to ensure all treated soil is removed prior to construction of the new cell.

For lagoon construction, Manitoba Conservation's Environmental guidelines require that the proposed dykes and bottom of the proposed cells be provided with a layer consisting of at least one metre of soil having a permeability of less than 1×10^{-7} cm/s. The proposed expansion location consists where such clay is present. The cohesive, high plasticity brown clay at a depth of 1.5 m was tested and achieved a hydraulic conductivity test result of 2.0×10^{-8} cm/s, thus meeting the guidelines.

The new cells will be constructed as detailed in the drawings. The interior and exterior side slopes of the constructed cell will be 4:1. The proposed secondary cell will have a 1.5 metre operating depth with a minimum 1.0 metre freeboard. The dykes will be constructed with in-situ material in 150 mm lifts compacted to 95% Standard Proctor density. The moisture content of the material should be minus two percent to plus 3 percent of optimum moisture as determined by the Standard Proctor test. Any unsuitable material such as coarse gravel and boulders should be removed. The top of the dykes will range from 3.0 m to 5.0 m wide. The 5.0 m wide dykes permit semi-trailer access to all secondary cells of the lagoon. The 1.0 m surface clay liner of the new secondary cell will be tested and the results of the testing will be reported to Manitoba Conservation.

A perimeter drainage ditch will be constructed around the new cells, if required. Other ditching will be located as shown on the drawings. For disturbed areas where sediment or erosion control is deemed necessary, the contractor will be required to employ appropriate measures.

The interior dykes will be armoured with rip rap to prevent wave erosion. Rip rap is also proposed for the inlet and outlet areas of the inter-cell and discharge piping. All inter-cell and discharge piping and valves will be located as shown on the design drawings.

6 ENVIRONMENTAL IMPACTS

6.1 ODOUR CONSIDERATIONS

It is expected that the expanded facility will operate without causing any significant odour problems. The existing secondary cell, which will become the converted primary cell, is designed for the flows with a 56 kg-BOD₅/ha/d loading. The only time of the year that some minor odours may be present is during the spring while the ice thaws. During the winter, ice cover largely prevents free oxygen from entering the water. This condition leads to the production of hydrogen sulphide gas (H₂S) during the winter by bacteria that do not require free oxygen. These accumulated gases dissipate quickly into the atmosphere when the ice breaks and the pond returns to a non-odorous condition.

The closest residence to the lagoon is located approximately 230 metres away (to the west) of the existing primary cell. With the existing primary and secondary cells exchanging locations, the converted primary cell will be relocated farther to the east, allowing greater than 300 m setback distance from this existing residence. The converted secondary cell, will remain within the 300 m setback distance. The new secondary cell lies over 500 metres away, which meets the Manitoba Conservation minimum setback distance of 300 metres.

6.2 LAND IMPACT

The existing lagoon was constructed in the year 1980 and the surrounding land has continued in its agricultural use without issue. The R.M. has operated their landfill and soil treatment cells to the east and south of the lagoon also without issue. Through information provided by the R.M. of Macdonald, the existing lagoon land and the land intended for lagoon development are designated as "EV", Environmental Policy Area. The existing lagoon was constructed to current specifications and there has been no indication that the liner has been compromised in any way. Since the land that the expanded cell will be constructed on contains treated petrochemical contaminated soil, this soil will need to be removed and used for fill or cover in the adjacent waste disposal grounds.

Section 2.3 Description of Existing Land Use should be consulted for additional information.

6.3 SURFACE WATER

From the discharge point into the existing ditch, the treated effluent will flow through this ditching into the Wheatland Drain and then travel 1.5 km to the La Salle River. Perimeter ditching will be maintained and extended to provide positive drainage for surface water around the lagoon, if required. Any local field drains that are interrupted by construction will be acceptably re-established or rerouted if no other alternative exists.

The Community of Sanford and the proposed lagoon facility are in the Lower La Salle River Watershed (No. 22). Figure 3.1 illustrates this beginning of the discharge route in the specified watershed.

The water licensing branch of Manitoba Water Stewardship was consulted to provide a list of water users along the drainage route. There are two licensed water users, both downstream approximately 10 km from the discharge point into the Wheatland Drain (Appendix E).

6.3.1 FUEL STORAGE ON SITE

The proposed facility does not require the onsite storage of gasoline or diesel fuel. During construction and upgrading, the contractor will be required to ensure that all equipment is properly maintained to prevent leaks and spills of fuel and motor fluids. Refuelling of equipment will not be within 100 metres of a water body, stream or wetland.

6.4 GROUNDWATER

Presently, there is a preliminary groundwater report prepared by the Planning Branch of the Water Resources Division for this area. Groundwater is readily available and fresh in the area east of the Red and Rat Rivers. The main aquifer in the area is the carbonate bedrock (limestone and dolostone) that underlies the entire area but bears freshwater mostly in the areas east of the Red and Rat Rivers. The depth to the carbonate bedrock ranges from 12 m to 40 m. Minor shallow sand aquifers were found along the La Salle River meander belt and along one of its tributaries near Starbuck. The well yields of the main aquifer are adequate for moderate industrial and municipal requirements and groundwater quality ranges from fair to excellent.

A review of the Groundwater Pollution Hazard Map shows that the property is located outside a groundwater pollution hazard area.

Based on the drainage map of the area, groundwater flow at the site is immediately towards the east and eventually heading to La Salle River.

The design of the new lagoon complies with Manitoba Conservation guidelines and will therefore sufficiently contain the influent wastewater. There have been no indicators in the 35+ years of operation that the existing lagoon liners have been compromised. The treated effluent intended for discharge will comply with the parameters listed in the new Environment Act Licence.

6.5 SPECIES IMPACT

A file search with the Biodiversity Conservation Wildlife and Ecosystem Protection Branch of Manitoba Conservation resulted in no occurrences in the specified area of NW 17-8-1 EPM in the R.M. of Macdonald. Correspondence is included in Appendix E.

6.6 FISHERIES

According to the 2013 Milani Report, the receiving watercourse of the treated effluent (filtrate) from the Sanford lagoon system is the Wheatland Drain and eventually the La Salle River which are both considered type A habitat (complex habitat, indicators present). A map of the area is included in Appendix E.

In order to protect any potential fish in the critical springtime spawning season, when effluent un-ionized ammonia tends to be high, the lagoon has been designed to the 227-day storage period. The lagoon will discharge after June 15th and will allow for significant conversion of toxic un-ionized ammonia into relatively benign nitrates.

6.6.1 FISHERIES ACT INFORMATION

The *Fisheries Act* controls and regulates the deposit of deleterious substances into water frequented by fish. According to subsection 36(3) of the *Fisheries Act*,

“no person shall deposit or permit the deposit of a deleterious substance of any type in water frequented by fish or in any place under any conditions where the deleterious substance or any other deleterious substance that results from the deposit of the deleterious substance may enter any such water.”

6.7 FORESTRY

There is no forestry activity in the area. No treed areas should be affected by the construction associated with the development.

6.8 HERITAGE RESOURCES

In an email dated May 11, 2015 from the Historic Resources Branch (Appendix E), it was stated that the potential to impact significant heritage resources is low, and therefore, the Historic Resources Branch has no concerns with the project.

6.9 SOCIO-ECONOMIC IMPACTS

The lagoon construction will result in a short-term boost to the construction industry in the area.

The construction equipment will be operated within the noise by-law restrictions of the R.M. of Macdonald.

6.10 PUBLIC INVOLVEMENT

Comments from concerned members of the public will be solicited as part of Manitoba Conservation and Water Stewardship review prior to issuing a licence.

7 MANAGEMENT PRACTICE

The expanded wastewater treatment facility is specifically designed to provide wastewater treatment and storage capacity for the existing infrastructure and proposed developments up to a population of 1,460. The expanded Sanford lagoon is designed to treat wastewater up to an average loading of 203 kg-BOD₅/d and store the treated effluent for 227 days. The facility will normally have a seasonal discharge between the allowable period from June 15th to October 31st. After the new development, the lagoon will consist of one primary and two secondary cells.

The proposed management and operation of the facility is discussed in the following sections.

7.1 OPERATION

Operation of the expanded wastewater treatment lagoon must comply with the specifications, limits, terms and conditions of the new Environment Act Licence, as is the case with the existing Licence. The R.M. of Macdonald must also be in compliance with WSER and the associated reporting outlined in the Regulation.

7.1.1 DISCHARGE

The expanded lagoon facility will be capable of storing the Community of Sanford's wastewater for 227 days at the design loading. In effect, until the design loads are reached, the lagoon will provide storage in excess of 227 days, if the need should arise for any reason.

The planned seasonal discharge will be from June 15 through to November 1 or periods within. A minimum of three weeks prior to the June 15th, valves will be manipulated to isolate one of the secondary cells for a period of two weeks prior to testing. This schedule allows for one week to obtain the laboratory results. The other non-isolated secondary cell will continue to receive the primary treated effluent. Testing shall be conducted according to the current *Environmental Act Licence* and the *Wastewater Systems Effluent Regulation*. All testing will occur in the secondary cells prior to discharge.

Manitoba Conservation and Water Stewardship generally requires treated effluent to have total suspended solids <25 mg/L, BOD₅ < 25 mg/L, fecal coliform MPN of <200 organisms/100 mL, and chlorine <0.02 mg/L and some nutrients removal requirements.

Once the test results of the effluent meet or exceed all parameters that should be satisfied prior to discharge, instituted by the new Environment Act Licence, the isolated cell may be discharged.

Once the secondary cell(s) are discharged, close the discharge valve(s), and reopen the valve(s) between the primary cell and the secondary cell(s). This will allow the water levels in the cells to equalize. In many cases a sufficient amount of treated effluent is discharged from the secondary cell(s) using this procedure to permit operation until the next scheduled discharge period. However, it may be necessary to discharge additional treated effluent to have enough storage for the wastewater flows in the following operational season.

The discharge of the secondary cells should be stopped at or before the November 1 deadline.

7.1.2 MAINTENANCE, RECORD KEEPING AND INSPECTION

The R.M. of Macdonald already has a routine maintenance, record keeping and inspection schedule in place. The record keeping and inspection list will include but is not limited to:

1. Daily Records – Water consumption and lift station pumping records should be collected and retained for future estimation of flows to the wastewater treatment lagoon. Septic hauling records

- (dates and volumes) from the individual haulers trucking to the lagoon should also be collected and retained, if applicable.
2. Weekly Records - The weekly summer inspection would consist of recording the following: the water level, aeration bubbles, presence of odours and their source, and presence of floating objects (removal), levels in chemical supply tankage. The summer maintenance should also include grass cutting on the dykes, if necessary, elimination of emergent vegetation, extermination of burrowing animals, repair of the dykes and rip rap if damaged by wind erosion and wave action, repair of the fence and gate. Recording blower hour readings and other output readings.
 3. Periodic Winter Inspection is confined to inspecting for frozen piping, checking if the water level in the cells is as it should be.
 4. Discharge Records - The records should contain all treated effluent quality analyses, dates of discharge, discharge procedure followed, water levels and other pertinent data.

8 SCHEDULE AND FUNDING

It is anticipated that the Environment Act Licence process will be finalized by the winter of 2015 and tendering of the project will begin in early 2016 (Figure 8.1). Construction is proposed for spring/summer 2016, concluding in the fall.

Project funding will be from designated municipal reserves, developer contributions and any grant funding that is available.

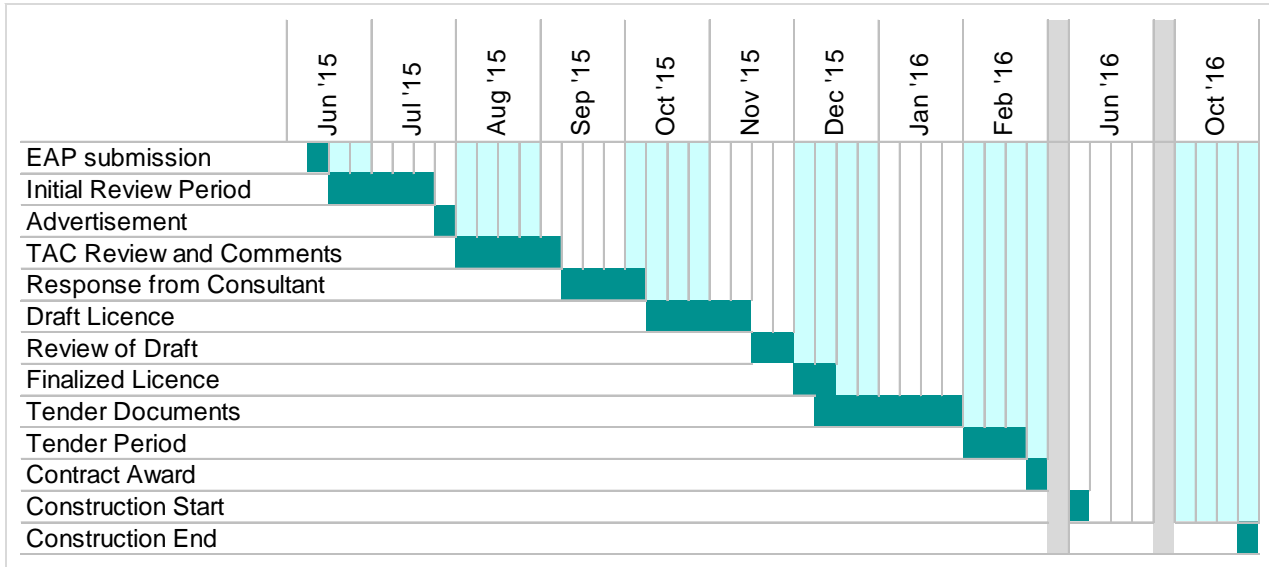

FIGURE 8.1: SCHEDULE – EAP SUBMISSION TO END OF CONSTRUCTION

9 REFERENCES

Statistics Canada. 2012. Sanford, Manitoba (Code 460083) and Sanford, Manitoba (Code 460083) (table). Census Profile. 2011 Census. Statistics Canada Catalogue no. 98-316-XWE. Ottawa. Released October 24, 2012. <http://www12.statcan.gc.ca/census-recensement/2011/dp-pd/prof/index.cfm?Lang=E> (accessed April 8, 2015).

Chambers P.A., M. Guy, E.S. Roberts, M.N. Charlton, R. Kent, C. Gagnon, G. Grove, and N. Foster. 2001. *Nutrients and their impact on the Canadian environment*. Agriculture and Agri-Food Canada, Environment Canada, Fisheries and Oceans Canada, Health Canada and Natural Resources Canada. 241 p.

Government of Canada, 2015. *Wastewater Systems Effluent Regulations*. Minister of Justice. SOR/2012-139. 80 p.

Milani, D.W. 2013. *Fish community and fish habitat inventory of streams and constructed drains throughout agricultural areas of Manitoba (2002-2006)*. Can. Data Rep. Fish. Aquat. Sci. 1247: xvi + 6,153 p.

Government of Canada, 2015. *Fisheries Act*. Minister of Justice. R.S.C., 1985, c. F-14. 61 p.

Appendix A

STATUS OF TITLE

TE: 1993/03/09
ME: 08:21
PORT

MANITOBA
DUPLICATE TITLE

TITLE NO: 1289566
PAGE: 1

STATUS OF TITLE..... ACCEPTED
ORIGINATING OFFICE..... WINNIPEG
REGISTERING OFFICE..... WINNIPEG
REGISTRATION DATE..... 1993/02/11
COMPLETION DATE..... 1993/03/01
PRODUCED FOR: MONK, GOODWIN
BY: A.SLOBODIAN
LTO BOX NO: 114
CONSOLIDATION..... NO

LEGAL DESCRIPTION:

THE RURAL MUNICIPALITY OF MACDONALD

IS REGISTERED OWNER SUBJECT TO SUCH ENTRIES RECORDED HEREON IN THE FOLLOWING DESCRIBED LAND:

PUBLIC WORKS, PLAN 15508 WLTO
IN NW 1/4 17-8-1 EPM

CHARGES:

NO CHARGES EXIST ON THIS TITLE

ADDRESS(ES) FOR SERVICE:

EFFECT	NAME AND ADDRESS	POSTAL CODE	FIRM NUMBER
ACTIVE	THE RM OF MACDONALD BOX 100 SANFORD, MB	ROG 2J0	

ORIGINATING INSTRUMENT(S):

REGISTRATION NUMBER	TYPE	REG. DATE	CONSIDERATION	SWORN VALUE
1644640 WPG	T	1993/02/11	1.00	50000.00

PRESENTED BY: MONK, GOODWIN
FROM: HER MAJESTY THE QUEEN IN OF MANITOBA
TO: THE RURAL MUNICIPALITY OF MACDONALD

FROM TITLE NUMBER(S):

1288223 WPG ALL	G42783 WPG BAL
B25510 WPG BAL	903796 WPG PART

DUPLICATE PRODUCED FOR..... MONK, GOODWIN ON 1993/03/09
ADDRESS..... 800-444 ST. MARY AVE.
WPG., MAN.
POSTAL CODE..... R3C 3T1

ACCEPTED THIS 11TH DAY OF FEBRUARY, 1993
BY J.MOFFAT FOR THE DISTRICT REGISTRAR OF
THE LAND TITLES DISTRICT OF WINNIPEG.

CERTIFIED 1993/03/09 X 
FOR THE DISTRICT REGISTRAR

Appendix B

EXISTING ENVIRONMENT ACT LICENCE

Environment Act Licence Loi sur l'environnement Licence

Manitoba
Environment
Environnement
Manitoba



Licence No./Licence n° 857 R

Issue Date/Date de délivrance October 12, 1979

Revised: August 27, 1998

IN ACCORDANCE WITH THE MANITOBA ENVIRONMENT ACT (C.C.S.M. c. E125)
THIS LICENCE IS ISSUED PURSUANT TO SECTION 11(1) TO:

THE RURAL MUNICIPALITY OF MACDONALD; "the Licencee"

for the operation of the Development being a wastewater treatment lagoon, servicing the unincorporated village of Sanford, located in the Northwest quarter of Section 17, Township 8, Range 1 EPM in the Rural Municipality of Macdonald and with discharge of treated effluent to the waters of the LaSalle River, via the Wheatland Drain, in accordance with the Proposal filed on March 26, 1979, and the Notice of Alteration dated December 9, 1993, and subject to the following specifications, limits, terms and conditions:

DEFINITIONS

In this Licence,

"**Director**" means an employee so designated pursuant to The Environment Act;

"**effluent**" means treated wastewater flowing or pumped out of the wastewater treatment lagoon or sewage treatment plant;

"**fecal coliform**" means aerobic and facultative, Gram-negative, nonspore-forming, rod-shaped bacteria capable of growth at 44.5° C, and associated with fecal matter of warm-blooded animals;

"**five-day biochemical oxygen demand**" means that part of the oxygen demand usually associated with biochemical oxidation of organic matter within five days at a temperature of 20° C;

"**hydraulic conductivity**" means the quantity of water that will flow through a unit cross-sectional area of a porous material per unit of time under a hydraulic gradient of 1.0;

"**MPN Index**" means the most probable number of coliform organisms in a given volume of wastewater which, in accordance with statistical theory, would yield the observed test result with the greatest frequency;

"**primary cell**" means the first in a series of cells of the wastewater treatment lagoon system and which is the cell that receives the untreated wastewater; and

"**total coliform**" means a group of aerobic and facultative anaerobic, Gram-negative, nonspore-forming, rod-shaped bacteria, that ferment lactose with gas and acid formation within 48 hours at 35° C, and inhabit predominantly the intestines of man or animals, but are occasionally found elsewhere and include the sub-group of fecal coliform bacteria.

LIMITS, TERMS, CONDITIONS AND SPECIFICATIONS

1. The Licencee shall ensure that the hydraulic conductivity of the interior of the said wastewater treatment lagoon does not exceed 10^{-7} centimetres per second over the entire lagoon.
2. The Licencee shall operate and maintain the wastewater treatment lagoon in such a manner that the organic loading on the primary cell of the said sewage treatment lagoon system does not exceed 56 kilograms per hectare per day, as indicated by the five-day biochemical oxygen demand.
3. The Licencee shall not discharge effluent from the wastewater treatment lagoon:
 - a) where the organic content of the effluent, as indicated by the five day biochemical oxygen demand, is in excess of 30 milligrams per litre;
 - b) where the fecal coliform content of the effluent, as indicated by the MPN index, is in excess of 200 per 100 millilitres of sample;
 - c) between the 1st day of November of any year and the 15th day of June of the following year; or
 - d) during periods of water withdrawal from the LaSalle River for filling the reservoirs at the Sanford Water Treatment Facility.
4. The Licencee shall actively participate in any future nutrient reduction program for the LaSalle River watershed, providing that the nutrient reduction program addresses both point and non-point sources of nutrients.

REVIEW AND REVOCATION

- A. This Licence replaces Licence No. 857 which is hereby rescinded.
- B. If, in the opinion of the Director, the Licencee has exceeded or is exceeding or has or is failing to meet the specifications, limits, terms, or conditions set out in this Licence, the Director may, temporarily or permanently, revoke this Licence.
- C. If, in the opinion of the Director, new evidence warrants a change in the specifications, limits, terms or conditions of this Licence, the Director may require the filing of a new proposal pursuant to Section 11 of The Environment Act.



Larry Strachan, P. Eng.
Director
Environment Act

Appendix C

GEOTECHNICAL REPORT

**GEOTECHNICAL REPORT
PROPOSED SANFORD WASTEWATER STABILIZATION
POND EXPANSION
SANFORD, MANITOBA**

**Prepared for:
R.M. of Macdonald**

**Project No: 141-21811-00
May, 2015**



**WSP Canada Inc.
1600 Buffalo Place
WINNIPEG, MB R3T 6B8**

TABLE OF CONTENTS

1.0	INTRODUCTION	1
2.0	BACKGROUND.....	1
3.0	TOPOGRAPHY	1
4.0	FIELD METHODOLOGY AND TESTING.....	2
5.0	SUBSURFACE CONDITIONS.....	2
	5.1 SOIL PROFILE/GROUNDWATER.....	2
	5.2 LABORATORY TESTING.....	3
6.0	DESIGN CONSIDERATIONS	3
7.0	ADDITIONAL CONSIDERATIONS	6
8.0	STANDARD LIMITATIONS.....	7

Appendix A – Site Plan

Appendix B – Testhole Logs and Well Logs

Appendix C – Laboratory Test Results

Appendix D – Hydraulic Conductivity Report

1.0 INTRODUCTION

The Rural Municipality of Macdonald is located in south central Manitoba and is situated adjacent to the southwestern boundary of Winnipeg, Manitoba's capital city. As part of future development for the Community of Sanford within the R.M. of Macdonald, a geotechnical investigation of the proposed wastewater lagoon expansion site located at NW 1/4 Sec. 17-8-1 EPM was conducted.

This report deals with the site selection of the future wastewater lagoon based on the soil conditions with respect to the recent Environmental Act passed in 1988. Manitoba Conservation's Environmental guidelines require that the dykes and the bottom of any lagoon be provided with a layer consisting of at least one metre of soil having a permeability of 1×10^{-7} cm/s or less or equivalence, i.e. the used of plastic liner.

2.0 BACKGROUND

At present, the Community of Sanford has an existing wastewater stabilization pond (WWSP) comprised of one primary cell and one secondary cell located in NW 1/4 Sec. 17-8-1 EPM.

3.0 TOPOGRAPHY

The proposed site is located within the Red River Plain sub-area. The Red River Plain sub-area is a clay basin with local flood plains and river levees, which occupies the flat areas in the lower-lying part of the Lake Agassiz basin. The area consists of lacustrine clay and alluvial deposits which range from a few metres to 13 m or greater in thickness. Limestone bedrock below thick clay and till layers (see the attached nearest well log of NW 19-8-1E) underlies much of the surficial deposits approximately 20 m below grade.

4.0 FIELD METHODOLOGY AND TESTING

The subsoils encountered were visually classified to the full extent in the testhole and representative soil samples were recovered at regular depth intervals and some samples were submitted for moisture content tests. Pocket penetrometer tests were conducted on the cohesive soil to determine the approximate unconfined compressive strength and relative density respectively. In addition, one Shelby Tube soil sample was obtained and submitted for hydraulic conductivity testing. Any groundwater seepage and sloughing encountered in the testholes were noted.

The field investigation was undertaken on January 5, 2015. A tracked-drill rig was used to drill a total of 6 testholes between 3 m and 7.6 m depths below grade. The testhole locations are shown on the site plan in Appendix A. Detailed descriptions of the soil profiles in each testhole are shown on the attached logs, TH1 to TH6 in Appendix B. Laboratory test results for moisture contents and hydraulic conductivity are attached in Appendix C.

5.0 SUBSURFACE CONDITIONS

5.1 SOIL PROFILE/GROUNDWATER

The general soil profile reveals a topsoil/fill layer of approximately 150 mm to 2400 mm followed by a thick clay layer, which extended to the bottom of each testhole, 7.6 m below grade. High plasticity clay was observed beneath the topsoil/fill layer.

No seepage and caving conditions were observed from the testholes. Detailed description of the testholes, TH1 to TH6, are shown in Appendix B – Testhole Logs.

Groundwater

Presently, there is a preliminary groundwater report prepared by the Planning Branch of the Water Resources Division for this area. Groundwater is readily available and fresh in the area east of the Red and Rat Rivers. The main aquifer in the area is the carbonate bedrock (limestone and dolostone) that underlies the entire area but bears

freshwater only in the area east of the Red and Rat Rivers. The depth to the carbonate bedrock ranges from 12 m to 40 m. Minor shallow sand aquifers were found along the La Salle River meander belt and along one of its tributaries near Starbuck. The well yields of the main aquifer are adequate for moderate industrial and municipal requirements and groundwater quality ranges from fair to excellent.

A review of the Groundwater Pollution Hazard Map shows that the property is located outside a groundwater pollution hazard area.

Based on the drainage map of the area, groundwater flow at the site is immediately towards the east and eventually heading to La Salle River.

5.2 LABORATORY TESTING

In the laboratory, selected samples were submitted for moisture contents and one sample for hydraulic conductivity. The test results are shown in Appendix C.

As classified during the field investigation, the clay layer encountered at the site was visually classified as high plasticity clay beneath the topsoil/fill layer. Due to this reason, hydraulic conductivity of the in-situ clay at approximately 1.5 m (TH5) was tested.

The clay material of the upper 1.5m depths is a CH material based on visual classification. The estimated hydraulic conductivity of this material should range between 10^{-8} to 10^{-9} cm/sec.

The hydraulic conductivity of the in-situ clay obtained at 1.5 m depth for TH5 was 2.0×10^{-8} cm/sec.

6.0 DESIGN CONSIDERATIONS

The proposed WWSP will be designed in accordance with the Province of Manitoba Design Objectives for Standard Sewage Lagoons (1985).

The proposed cell will contain a liquid depth of 1.5 m and 1 m freeboard to minimize the effects of wave action and to provide stability. The inside and outside side slopes of the dykes will be 4H:1V. The top of the dykes will be designed to be, at minimum, 3 m wide to permit vehicles to be driven on the dyke crest. *Depths of more than 2.5 m (vertical height from the top of dyke to the bottom of lagoon) should not be attempted without further analysis (slope or settlement).*

For lagoon construction, Manitoba Conservation's Environmental guidelines require that the proposed dykes and bottom of the proposed cells be provided with a layer consisting of at least one metre of soil having a permeability of less than 1×10^{-7} cm/s. The proposed lagoon site consists mainly of an area where such clay is present.

The selected area, fortunately, consists mainly of upper CH clay with massive structure, which will meet the specified hydraulic conductivity of 1×10^{-7} cm/s. Based on the hydraulic conductivity test result of TH5 at 1.5 m depth, the in-situ clay meets the Manitoba Conservation guideline for lagoon liner.

The intention is to cut at least 1.5 m depth of clay at TH5 to TH6 location and used the clay material as clay liner. However, significant clay fill material of poor quality was encountered at TH6. If this is the case, this clay fill should be removed and be used as backfill material on the outside slope of dykes. Otherwise and if needed, a borrow pit consisting of high plasticity clay should be used as back-up for the clay liner.

The liner of the existing lagoon is unknown. To connect the existing lagoon to the expansion lagoon, it is suggested that the outside slope of the existing lagoon be lined with 1 m clay liner.

Based on our field investigation, well logs from Manitoba Water Well reports and laboratory analysis, the proposed pond liner (base and interior) for the expansion site should be constructed with a 1 m clay liner.

Ensure that the outside slope of the existing dyke should be covered with at least 1 m of CH material compacted to at least 95% STD proctor density during the construction of the expansion.

During construction of the proposed expansion cell, the following steps should be followed.

1. The entire area for the proposed pond should be stripped of vegetation, topsoil and organic material; the depth of stripping is approximately 150 mm (TH5) to 1200 mm (TH6). The stripped materials should be stockpiled and reused later for the outer slopes and top of the dykes.
2. Layout the proposed pond to the dimensions indicated in the design drawings.
3. For the proposed bottom and interior dykes, the liner should be compacted to 95% standard Proctor density at ± 2 to 3% of optimum moisture content with a sheepsfoot roller. *Any unsuitable material such as sand or high percentage silt materials should be removed and replaced with the recommended liner and compacted to 95% standard Proctor density.* Ensure that the liner (1 m clay liner) consists of at least one metre width of impervious clay compacted to at least a minimum of 95% standard Proctor maximum density in 150 mm to 200 mm lifts. A shrinkage factor of about 25% should be used in calculating volumes of material to be used.
4. The unsuitable material can be used as backfill on the outside face of the dykes. The embankment material should be placed in 150 mm lifts compacted with at least eight passes with a sheepsfoot roller having a foot pressure of no less than 700 kPa.

Further erosion control against wind and rain action using riprap placement on the dykes should be provided, if needed, after construction. A well-developed and maintained grass cover above the riprap should add integrity to the dykes.

The entire completed pond system should be fenced to keep people, children in particular away from the pond. All gates should be locked to prevent access.

Appropriate warning signs should be provided on the fence around the pond, to designate the nature of the facility, and to advise against trespassing.

We recommend that a minimum distance of 5 meters be maintained between the outside toe of the embankment and the fence.

7.0 ADDITIONAL CONSIDERATIONS

On the basis of the soil conditions encountered during drilling (i.e. mainly a clay/ clay fill subgrade), the recommended road pavement construction at this site should be as follows:

Pavement Thicknesses

	Truck Route	% Compaction
Base Coarse	150 mm	100% Std Proctor
Subbase	225 mm	100% Std Proctor

The above pavement sections should be constructed on a prepared clay/clay fill subgrade, which should be free of any fibrous organics, softened and disturbed soils. The average depth of site stripping is about 150 mm to 200 mm below ground surface; depth of topsoil layer near the expansion site. The prepared subgrade should be proof rolled with a heavy sheepsfoot roller (min. 20 passes) which translates to at least 95% Standard Proctor and inspected by a qualified geotechnical engineer prior to the placement of the overlying granular fill.

The granular base course and subbase materials should include organic-free, non-frozen, aggregate conforming to the Manitoba Highway gradation limits.

Where soft spots are encountered at the subgrade level, construction traffic should be restricted. Soft spots should be excavated with a large backhoe fitted with a smooth bucket, to at least 300mm below the underside of the subbase and replaced with a 300mm thick layer of 100mm down crushed aggregate/limestone. In this regard, the total granular fill thickness would be 675mm for truck access.

Sieve analysis and compaction testing of the granular base and subbase materials should be conducted by qualified geotechnical personnel to ensure that the materials supplied and percent compactions are in accordance with design specifications.

8.0 STANDARD LIMITATIONS

The factual data, interpretations and recommendations contained in this report pertain to the specific project as described in this report and are not applicable to any other project, site location or party. The comments given in this report are intended only for the guidance of the design engineer. Contractors bidding on, or undertaking the work, should rely on their own investigations, as well as their own interpretations of the factual test data, as to how subsurface conditions may affect their work.

Soil descriptions in this report are based on commonly accepted methods of classification and identification employed in professional geotechnical practice. Classification and identification of soil involves judgement and WSP Canada Inc. does not guarantee descriptions as exact, but infers accuracy only to the extent that is common in current geotechnical practice.

Soil formations are variable to a greater or lesser extent. The testhole logs indicate the approximate subsurface conditions only at the locations of the testhole. Boundaries between zones on the logs are often not distinct, but rather transitional, and have been interpreted. Subsurface conditions between test holes are inferred and may vary significantly from conditions encountered at the testhole.

Where conditions encountered at the site differ significantly from those anticipated in the report, either due to natural variability of subsurface conditions or construction activities,

it is a condition of the use, or reliance by the client, of this report that WSP Canada Inc. is notified of the changes and provided with an opportunity to review the recommendations of this report.

Prepared by: S.S. Urbano Jr., P. Eng.



APPENDIX A
SITE PLAN



1835 BIRLING PLACE
WINNEPEG, MANITOBA
CANADA R3T 8S6
PHONE: 204-477-8855 FAX: 204-474-2684
WWW.WSPGROUP.COM

CLIENT:

R.M. OF MACDONALD

CLIENT REF. #:

PROJECT:

SANFORD WASTEWATER STABILIZATION
POND EXPANSION

IS

IS	RE	DATE	DESCRIPTION
1		2015/05/20	GEOTECHNICAL REPORT

PROJECT NO.:

141-21811-00

DATE:

2015/05/20

ORIGINAL SCALE:

1:2500

DESIGNED BY:

DTCB

DRAWN BY:

DTCB

CHECKED BY:

SSU

DISCIPLINE:

GEOTECHNICAL

TITLE:

TESTHOLE LOCATIONS

SHEET NUMBER:

G-01

1 OF 1

SHEET #:

REV. #

0

ISSUED FOR GEOTECHNICAL REPORT

DATE OF: 2015/05/20

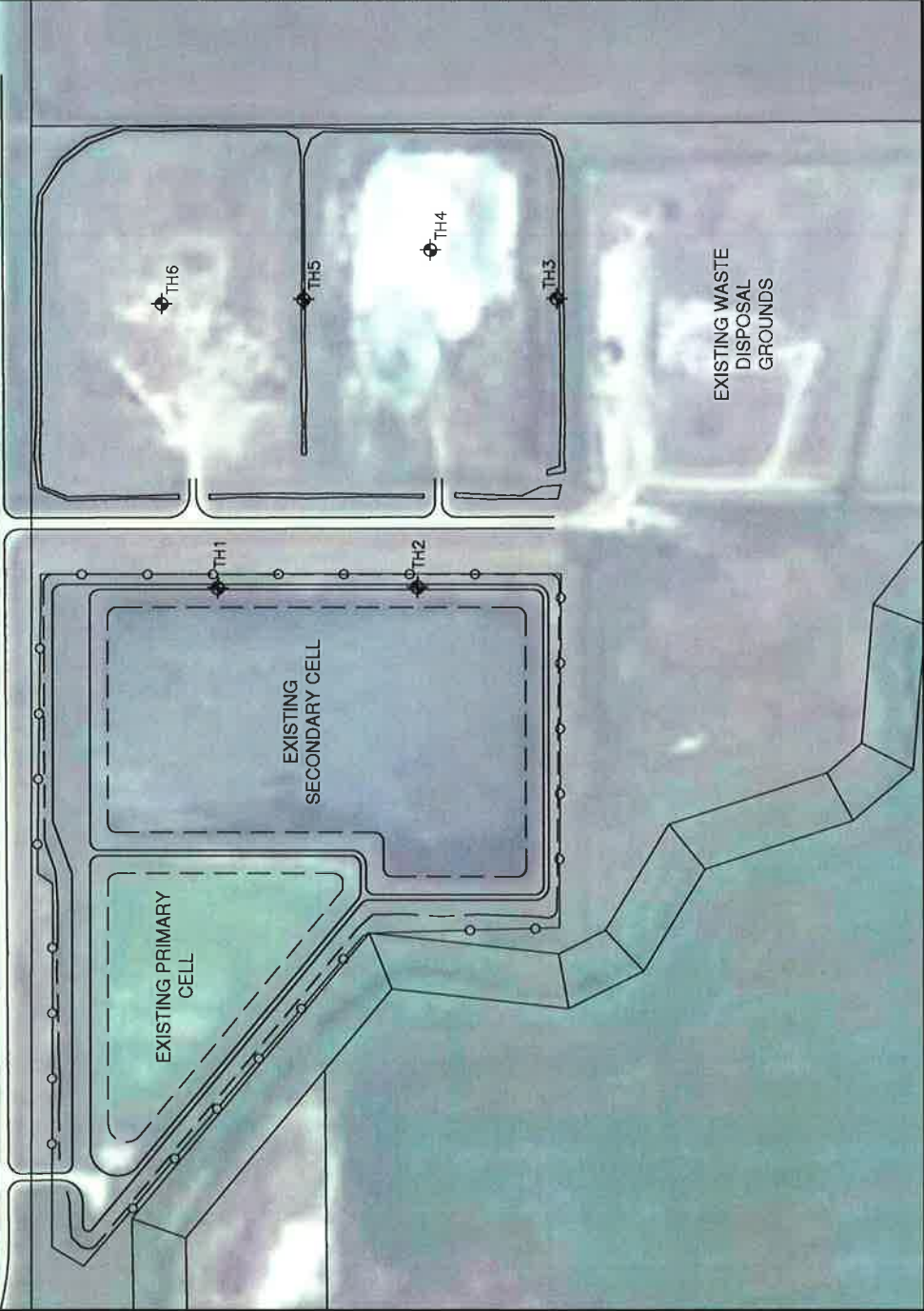

STAMP

J387

APPENDIX B

TESTHOLE LOGS and WELL LOGS

Project No: 141-21811-00

Client: RM of Macdonald

TH1

Project: Sanford WWSP Expansion

Location: Sanford, Manitoba



Enclosure:

Engineer: SSU

SUBSURFACE PROFILE				SAMPLE		Water Content %
Depth	Symbol	Description	Depth/Elev., m	PP(kPa)	SPT, N	
0		Ground Surface	238			
0 to 2.7		FILL 2100mm thick; 100mm of ROOTLETS over 2000mm of CLAY FILL, mixed, high plasticity clay, brown and black; frost to .75m				
2.7 to 7.6		CLAY stiff, olive-grey, fissured, high plasticity; brown at 2.7m; trace of sulphate inclusions at 4.5m to 7.6m. TESTHOLE IS DRY AFTER COMPLETION OF DRILLING.				
7.6 to 25			231	100		
				100		
				125		
				125		

Drill Method: S/S Auger

WSP Canada Inc.
1600 Buffalo Place
Winnipeg, MB.
R3T 6B8

Elevation: 238.2m

Drill Date: 01/05/15

Checked by: SSU

Hole Size: 125 mm

Sheet: 1 of 1

Project No: 141-21811-00

Client: RM of Macdonald

TH2

Project: Sanford WWSP Expansion

Location: Sanford, Manitoba



Enclosure:

Engineer: SSU

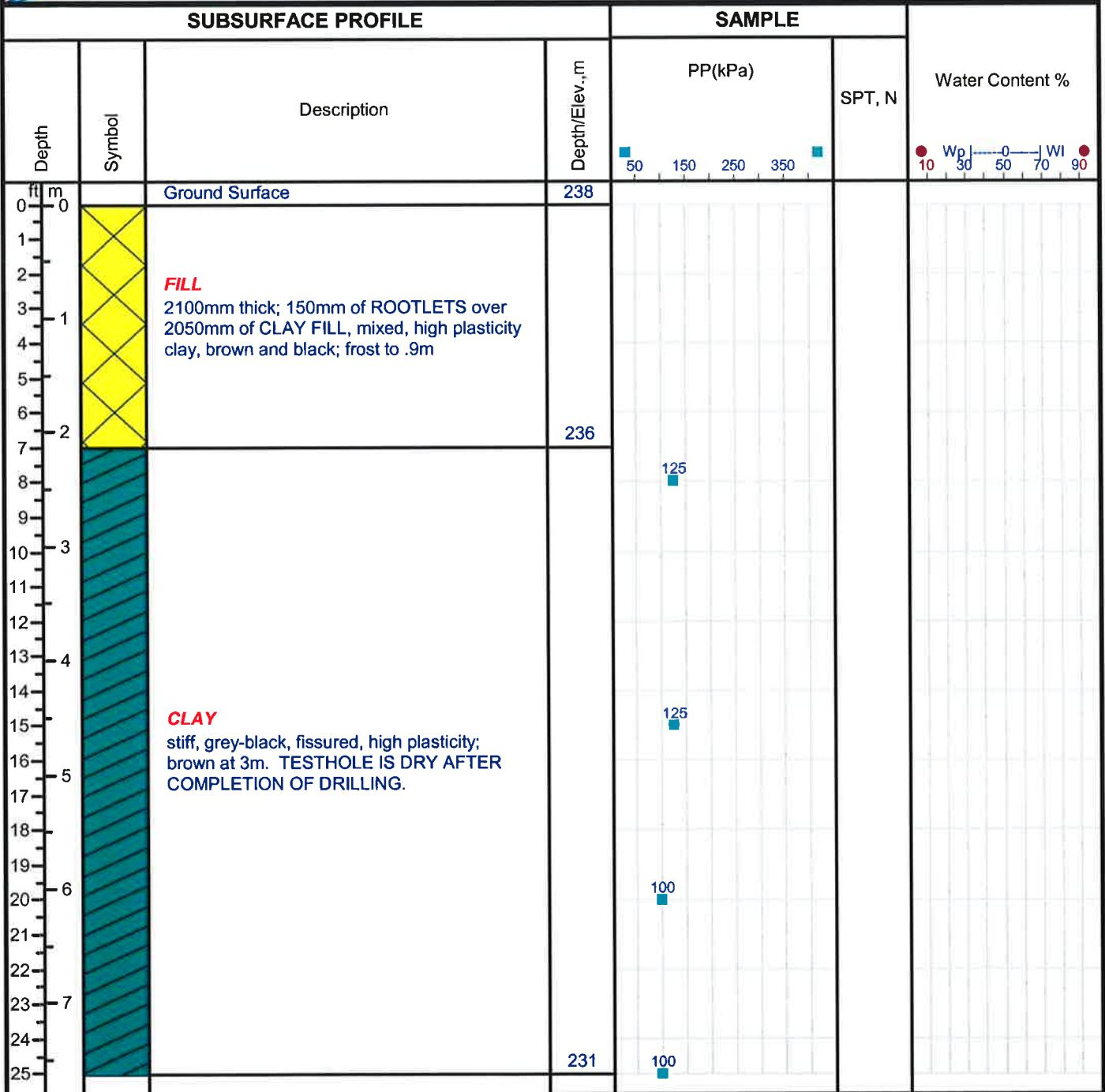

Drill Method: S/S Auger

WSP Canada Inc.
1600 Buffalo Place
Winnipeg, MB.
R3T 6B8

Elevation: 238.2m

Drill Date: 01/05/15

Checked by: SSU

Hole Size: 125 mm

Sheet: 1 of 1

Project No: 141-21811-00

Client: RM of Macdonald

TH3

Project: Sanford WWSP Expansion

Location: Sanford, Manitoba



Enclosure:

Engineer: SSU

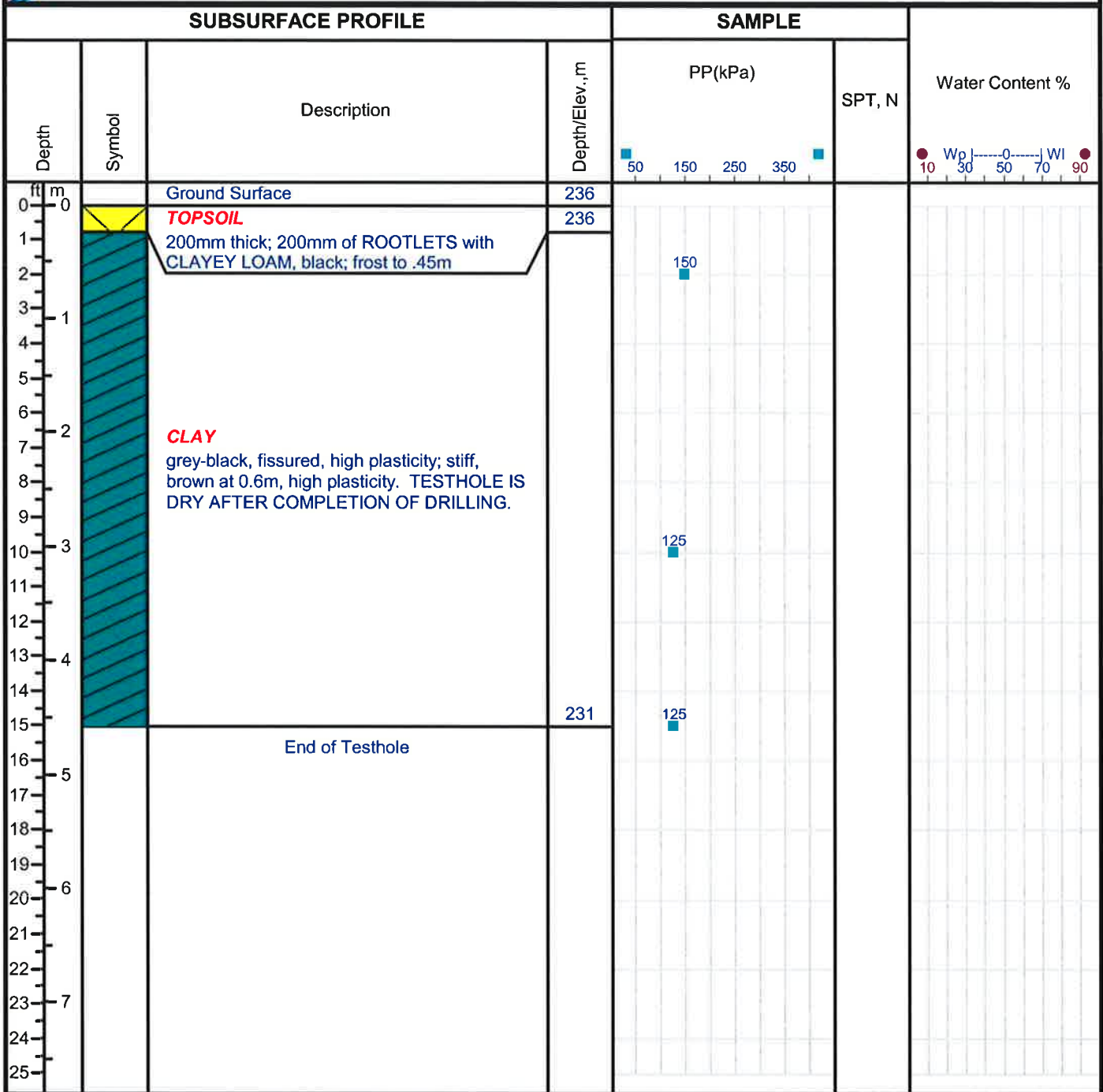

Drill Method: S/S Auger

WSP Canada Inc.
1600 Buffalo Place
Winnipeg, MB.
R3T 6B8

Elevation: 236.0m

Drill Date: 01/05/15

Checked by: SSU

Hole Size: 125 mm

Sheet: 1 of 1

Project No: 141-21811-00

Client: RM of Macdonald

TH4

Project: Sanford WWSP Expansion

Location: Sanford, Manitoba



Enclosure:

Engineer: SSU

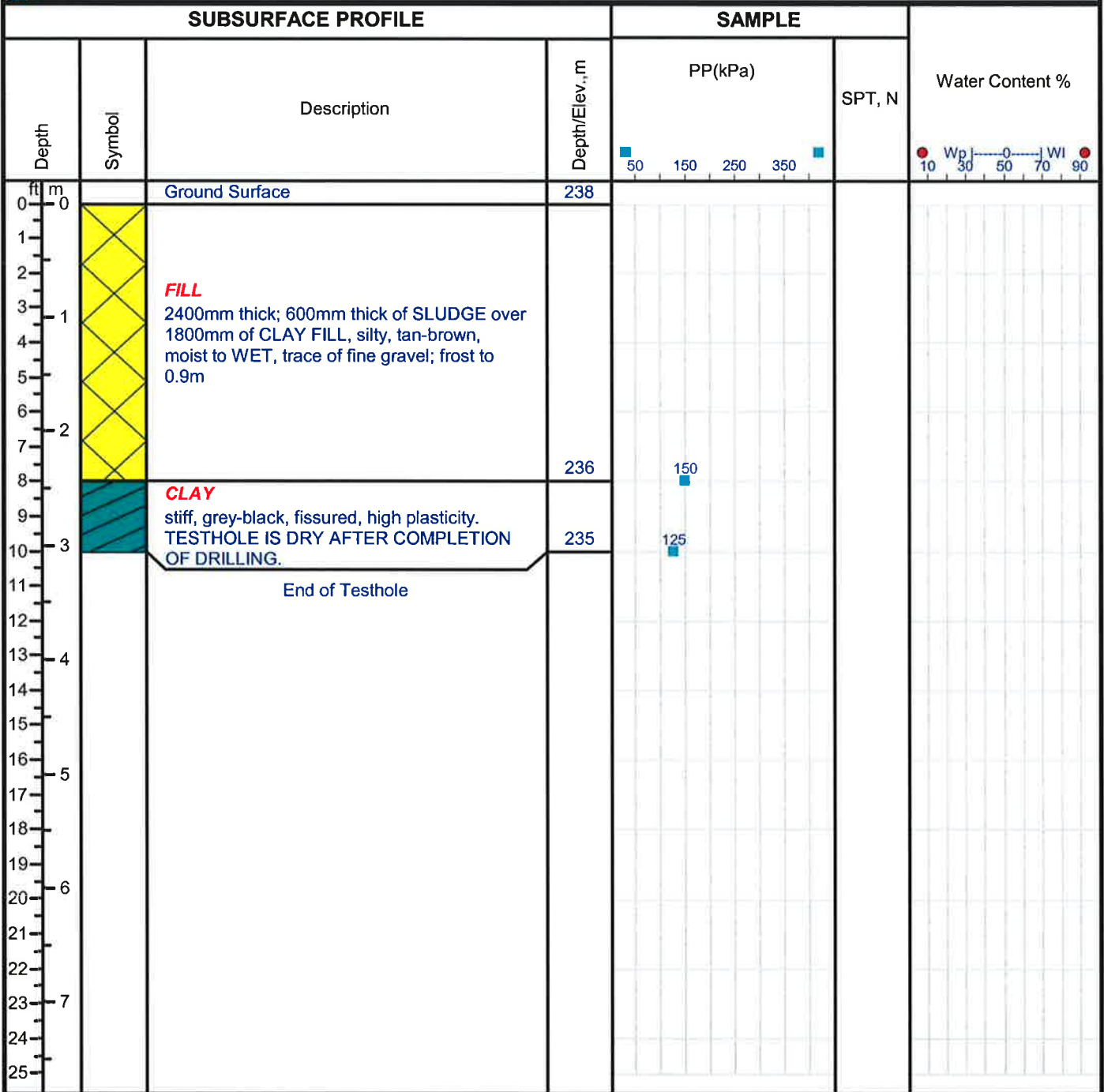

Drill Method: S/S Auger

WSP Canada Inc.
 1600 Buffalo Place
 Winnipeg, MB.
 R3T 6B8

Elevation: 238.5m

Drill Date: 01/05/15

Checked by: SSU

Hole Size: 125 mm

Sheet: 1 of 1

Project No: 141-21811-00

Client: RM of Macdonald

TH5

Project: Sanford WWSP Expansion

Location: Sanford, Manitoba



Enclosure:

Engineer: SSU

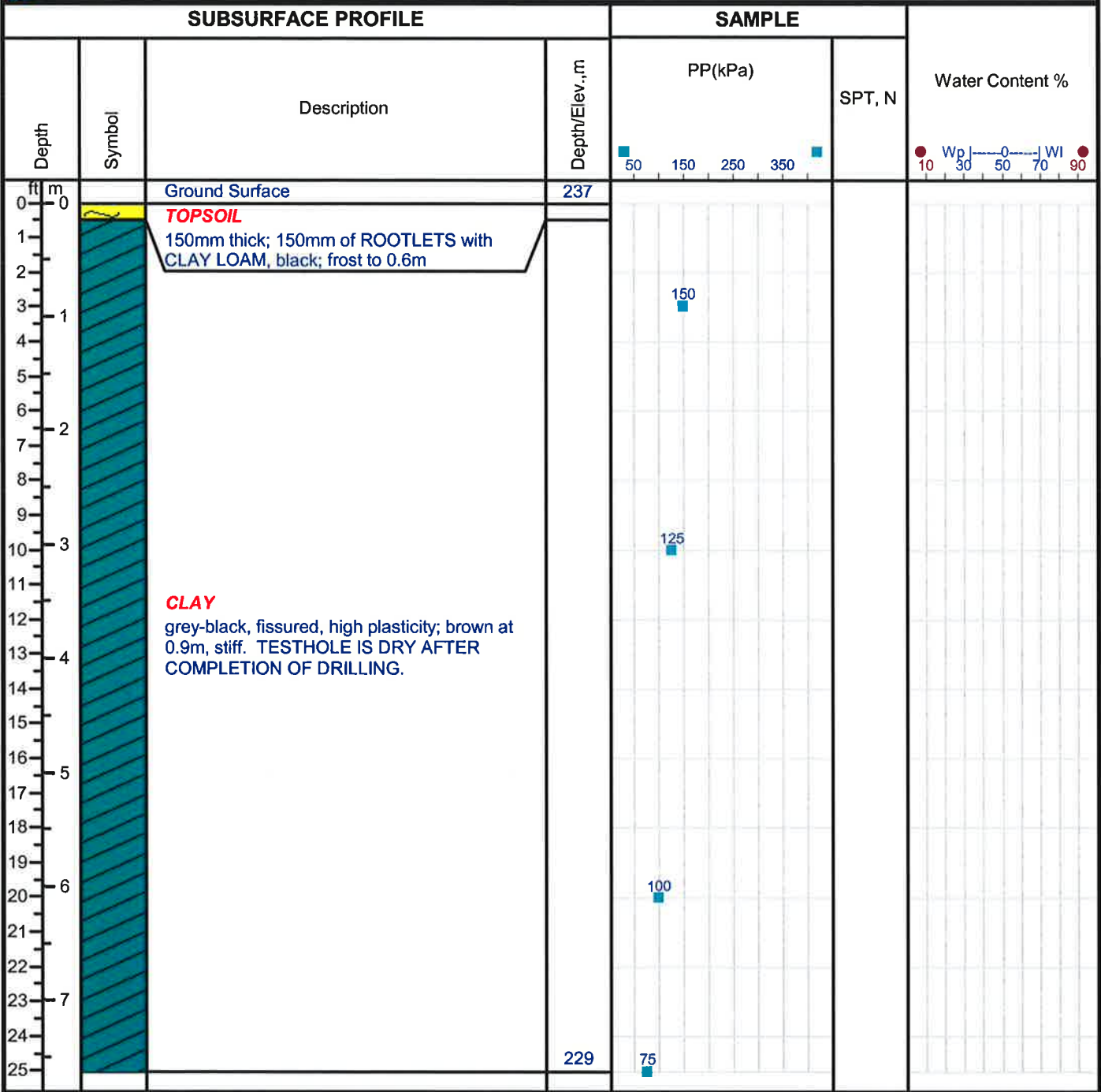

Drill Method: S/S Auger

WSP Canada Inc.
1600 Buffalo Place
Winnipeg, MB.
R3T 6B8

Elevation: 237.0m

Drill Date: 01/05/15

Checked by: SSU

Hole Size: 125 mm

Sheet: 1 of 1

Project No: 141-21811-00

Client: RM of Macdonald

TH6

Project: Sanford WWSP Expansion

Location: Sanford, Manitoba



Enclosure:

Engineer: SSU

SUBSURFACE PROFILE				SAMPLE		Water Content %
Depth	Symbol	Description	Depth/Elev., m	PP(kPa)	SPT, N	
0		Ground Surface	238			
1		FILL 1200mm thick; CLAY FILL, mixed, traces of limestone; frost to 1.2m				
2						
3						
4			236	150		
5						
6						
7						
8		CLAY stiff, grey-black, fissured, high plasticity; brown at 1.5m, stiff. TESTHOLE IS DRY AFTER COMPLETION OF DRILLING.				
9						
10				150		
11						
12						
13						
14						
15			233	125		
16		End of Testhole				
17						
18						
19						
20						
21						
22						
23						
24						
25						

Drill Method: S/S Auger

WSP Canada Inc.
1600 Buffalo Place
Winnipeg, MB.
R3T 6B8

Elevation: 237.5m

Drill Date: 01/05/15

Checked by: SSU

Hole Size: 125 mm

Sheet: 1 of 1

LOCATION: NW19-8-1E

Owner: WRB & MWSB
Driller: M & M Drilling Rivers Ltd.
Well Name: S-1
Well Use: TEST WELL
Water Use:
Date Completed: May 12, 1976

WELL LOG

From (ft.)	To (ft.)	Log
0	3.0	TOPSOIL
3.0	6.0	CLAY- LIGHT GREY
6.0	16.0	CLAY- LIGHT BROWN
16.0	34.0	CLAY- GREY, SOFT
34.0	34.5	BOULDER
34.5	44.0	CLAY- GREY, SOFT BOULDER AT 44 FEET
44.0	47.0	CLAY- GREY, SOFT
47.0	49.0	TILL- WHITE STONY, SOFT
49.0	65.0	TILL- WHITE STONY, HARD
65.0	77.9	LIMESTONE WHITE
77.9	80.9	LIMESTONE RED, SHALY

WELL CONSTRUCTION

From Material (ft.)	To (ft.)	Casing Type	Inside Dia.(in)	Outside Dia.(in)	Slot Size(in)	Type
0	70.0	casing	2.00			T & C
70.0	76.0	perforations	2.00			SL. PIPE

Top of Casing: ft. below ground

PUMPING TEST

Date:
Flowing Rate: 2.0 Imp. gallons/minute
Water level before pumping: ft. below ground
Pumping level at end of test: ?? ft. below ground
Test duration: hours, 50 minutes
Water temperature: ?? degrees F

REMARKS

SANFORD, NEAR FIREHALL, EC=10500 MM

LOCATION: 30-8-1E

Owner: D ROBBINS
Driller: SUBTERRANEAN (WINNIPEG) LTD.
Well Name:
Well Use: PRODUCTION
Water Use: Domestic
Date Completed: Jan 01, 1980

WELL LOG

From (ft.)	To (ft.)	Log
0	4.0	CLAY, BROWN
4.0	10.0	BROWN CLAY AND SILT
10.0	25.0	CLAY AND LAYERS OF GRAVEL
25.0	30.0	SILT AND MIXED GRAVEL

WELL CONSTRUCTION

From Material (ft.)	To (ft.)	Casing Type	Inside Dia. (in)	Outside Dia. (in)	Slot Size (in)	Type
0	30.0	casing	30.00			CORRUGATED GALVANIZED

Top of Casing: ft. below ground

PUMPING TEST

Date:
Flowing Rate: Imp. gallons/minute
Water level before pumping: ft. below ground
Pumping level at end of test: ?? ft. below ground
Test duration: hours, minutes
Water temperature: ?? degrees F

APPENDIX C

LABORATORY TEST RESULTS

**MOISTURE CONTENT OF SOIL
ASTM D2216**

CLIENT:	WSP	TEST NO:	1	PROJECT NO:	15-02-1
PROJECT:	Sanford	DATE SAMPLE	10-Jan-15	SAMPLED BY:	Client
PROJECT CONTACT:	SU	DATE TESTED:	11-Jan-15	TESTED BY:	GM
Test Hole No.	TH1	TH1	TH1	TH1	TH1
Depth	5'	10'	15'	20'	25'
Wt Wet Sample + Tare	172.5	249.1	263.3	202	257.8
Wt Dry Sample + Tare	125.9	190	182.8	137.9	180
Wt Water	46.6	59.1	80.5	64.1	77.8
Wt Tare	7.0	7.1	6.4	7.3	7.1
Wt Dry Sample	118.9	182.9	176.4	130.6	172.9
Moisture Content (%)	39.2	32.3	45.6	49.1	45.0
Test Hole No.	TH5	TH5	TH5	TH5	TH5
Depth	2.5'	5'	10'	15'	20'
Wt Wet Sample + Tare	222.5	186.6	224.7	226.3	197.9
Wt Dry Sample + Tare	163	138.4	154.9	159.6	140.2
Wt Water	59.5	48.2	69.8	66.7	57.7
Wt Tare	7.7	6.6	7.2	7.3	7.5
Wt Dry Sample	155.3	131.8	147.7	152.3	132.7
Moisture Content (%)	38.3	36.6	47.3	43.8	43.5
Test Hole No.	TH5				
Depth	25'				
Wt Wet Sample + Tare	190.6				
Wt Dry Sample + Tare	133.5				
Wt Water	57.1				
Wt Tare	6.7				
Wt Dry Sample	126.8				
Moisture Content (%)	45.0				
Test Hole No.					
Depth					
Wt Wet Sample + Tare					
Wt Dry Sample + Tare					
Wt Water					
Wt Tare					
Wt Dry Sample					
Moisture Content (%)					

APPENDIX D

HYDRAULIC CONDUCTIVITY REPORT



6 - 854 Marion Street, Winnipeg, Manitoba, R2J 0K4
Phone: (204) 233-1694 Fax: (204) 235-1579
E-mail: eng_tech@mts.net
www.eng-tech.ca

S A

March 31, 2014

File No. 15-035-01

WSP Canada Inc.
1600 Buffalo Place,
Winnipeg, MB
R3T 6B8

ATTENTION: Mr. Silvestre Urbano, P.Eng.

RE: Lagoon Expansion, Town of Sanford, Manitoba

ENG-TECH Consulting Limited (ENG-TECH) received a Shelby tube sample, labelled TH5, from the above location, which was requested for hydraulic conductivity. The hydraulic conductivity test data is outlined in Table 1, while the graphical representation of the hydraulic conductivity versus elapsed time is shown in Figure 1 attached.

ENG-TECH prepared the sample for hydraulic conductivity in accordance with ASTM D5084-03, *Standard Test Method for Measurement of Hydraulic Conductivity of Saturated Porous Materials using a Flexible Wall Permeameter*. The final hydraulic conductivity value (k_{20}) of 2.0×10^{-8} cm/sec was obtained for the sample identified as TH5.

ENG-TECH trusts the above is all the information you require. If you have any questions, please contact the undersigned.

Sincerely,
ENG-TECH Consulting Limited

Clark Hryhoruk, M.Sc., P.Eng.
President, Geotechnical Engineer



CDH/em

Attachments: Table 1 – Hydraulic Conductivity Test Data
Figure 1 – Hydraulic Conductivity Versus Elapsed Time (TH5)

**TABLE 1
HYDRAULIC CONDUCTIVITY TEST DATA
WWSP, TOWN OF EAST SELKIRK, MANITOBA**

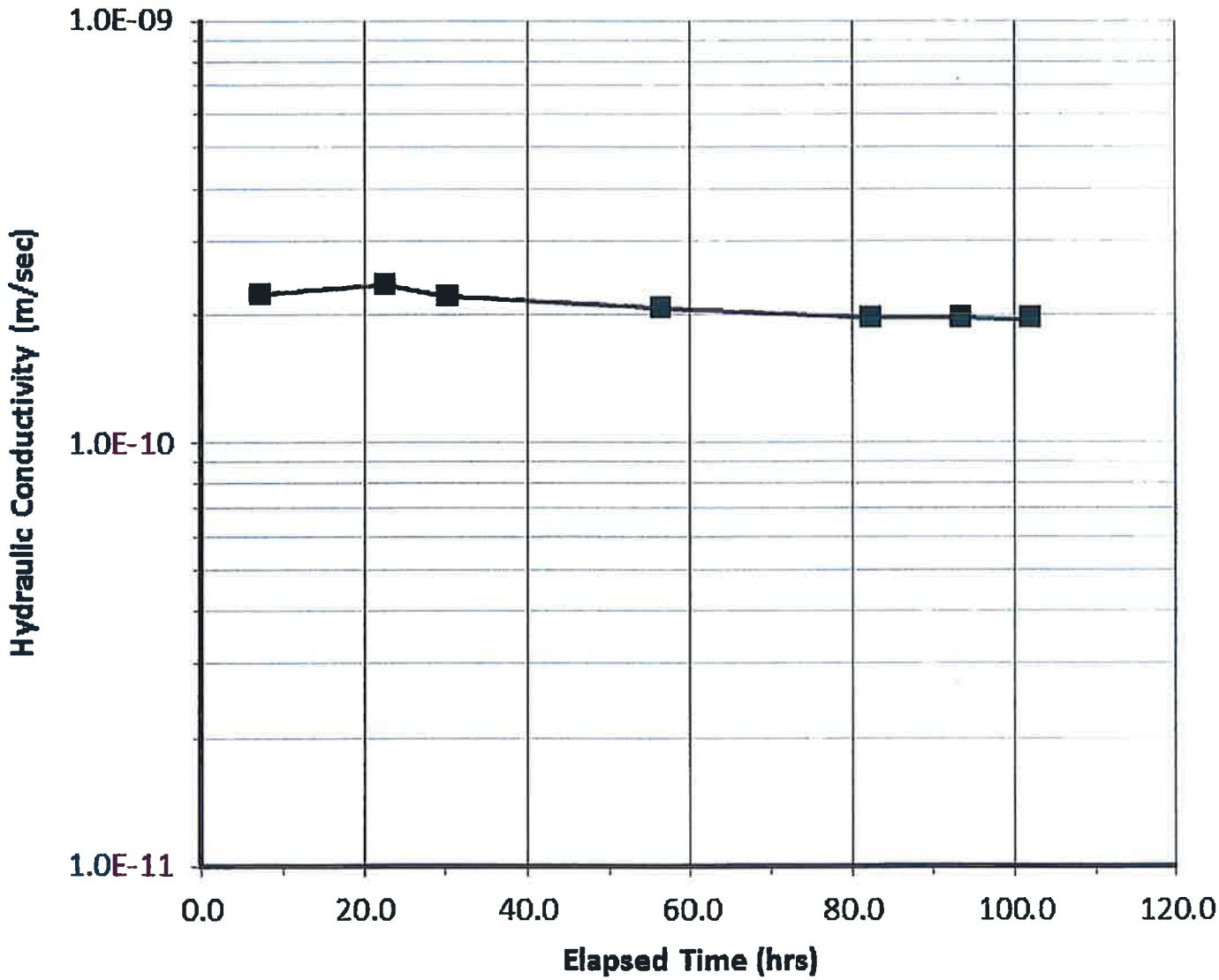
SAMPLE IDENTIFICATION	TH5
INITIAL VALUES	
ENG-TECH Reference No.	15-35-1-1
Length of Sample in Tube (cm)	61.0
Length (cm)	6.27
Diameter (cm)	7.10
Area (cm ²)	39.5
Volume (cm ³)	247.8
Water Content (%)	36.2
Bulk Dry Density (kg/m ³)	1353
Specific Gravity (G _s) (assumed)	2.70
Void Ratio	0.995
Degree of Saturation (%)	98.2
FINAL VALUES	
Length (cm)	6.33
Diameter (cm)	7.14
Area (cm ²)	40.0
Volume (cm ³)	253.2
Water Content (%)	38.8
Bulk Dry Density (kg/m ³)	1321
Specific Gravity (G _s) (assumed)	2.70
Void Ratio	1.044
Degree of Saturation (%)	~100
CONSOLIDATION PHASE	
Confining Pressure (kPa)	103.4
Pore Water Pressure (kPa)	82.7
Effective Stress (kPa)	20.7
PERMEATION PHASE	
Confining Pressure (kPa)	103.4
Pore Water Pressure (kPa)	82.7
Effective Stress (kPa)	20.7
Hydraulic Gradient	17.8
Permeant Fluid	Distilled Water
HYDRAULIC CONDUCTIVITY at TEST TEMPERATURE OF 21 °C (cm/sec)	2.0 x 10⁻⁸
HYDRAULIC CONDUCTIVITY at TEMPERATURE OF 20 °C (K₂₀) (cm/sec)	2.0 x 10⁻⁸



 6 - 854 Marion Street Winnipeg, MB R2J 0K4 Phone: (204) 233-1894 Fax: (204) 235-1579	ENG. STAMP:	 Certificate of Authorization ENG-TECH Consulting Limited No. 2475 Expiry: April 30, 2015	CLIENT: WSP CANADA INC.		PROJECT: LAGOON EXPANSION, TOWN OF SANFORD, MANITOBA	
			DATE: MARCH 2015	FILE No.: 14-035-01	DRAWN BY: ERM	FIGURE No.: 1

HYDRAULIC CONDUCTIVITY
VERSUS ELAPSED TIME
(TH5)

Appendix D

PLANS AND DETAILS

CONSULTANT:

PRELIMINARY
 NOT FOR CONSTRUCTION

SEAL:



CLIENT:

R.M. OF MACDONALD

CLIENT REF. #:

PROJECT:

COMMUNITY OF SANFORD
 WASTEWATER STABILIZATION POND
 EXPANSION

KEY PLAN:

DISCLAIMER:

THIS DRAWING AND DESIGN IS COPYRIGHT PROTECTED WHICH SHALL NOT BE USED, REPRODUCED OR REVISED WITHOUT WRITTEN PERMISSION BY WSP. THE CONTRACTOR SHALL CHECK AND VERIFY ALL DIMENSIONS AND UTILITY LOCATIONS AND REPORT ALL ERRORS AND OMISSIONS PRIOR TO COMMENCING WORK. THIS DRAWING IS NOT TO BE SCALED.

ISSUED FOR - REVISION:

NO.	DATE	DESCRIPTION
1	2015/06/09	EAP SUBMISSION

PROJECT NO: 141-21811-00	DATE: 2015/06/09
ORIGINAL SCALE: 1:2000	IF THIS BAR IS NOT 25mm LONG, ADJUST YOUR PLOTTING SCALE.
DESIGNED BY: D.T.G.B.	
DRAWN BY: D.T.G.B.	
CHECKED BY: J.S.B./R.W.W.	

DISCIPLINE: ENVIRONMENTAL INFRASTRUCTURE

TITLE:

 EXISTING SITE PLAN

SHEET NUMBER:
 C01
 1 OF 3

ISSUE:
 ISSUED FOR EAP
 DATE OF: 2015/06/09

REV #
 0



SW 1/4 Sec. 20 Twp. 8 Rge. 1 E.P.M.

SE 1/4 Sec. 20
 Twp. 8 Rge. 1
 E.P.M.

NE 1/4 Sec. 17
 Twp. 8 Rge. 1
 E.P.M.

NW 1/4 Sec. 17 Twp. 8 Rge. 1 E.P.M.

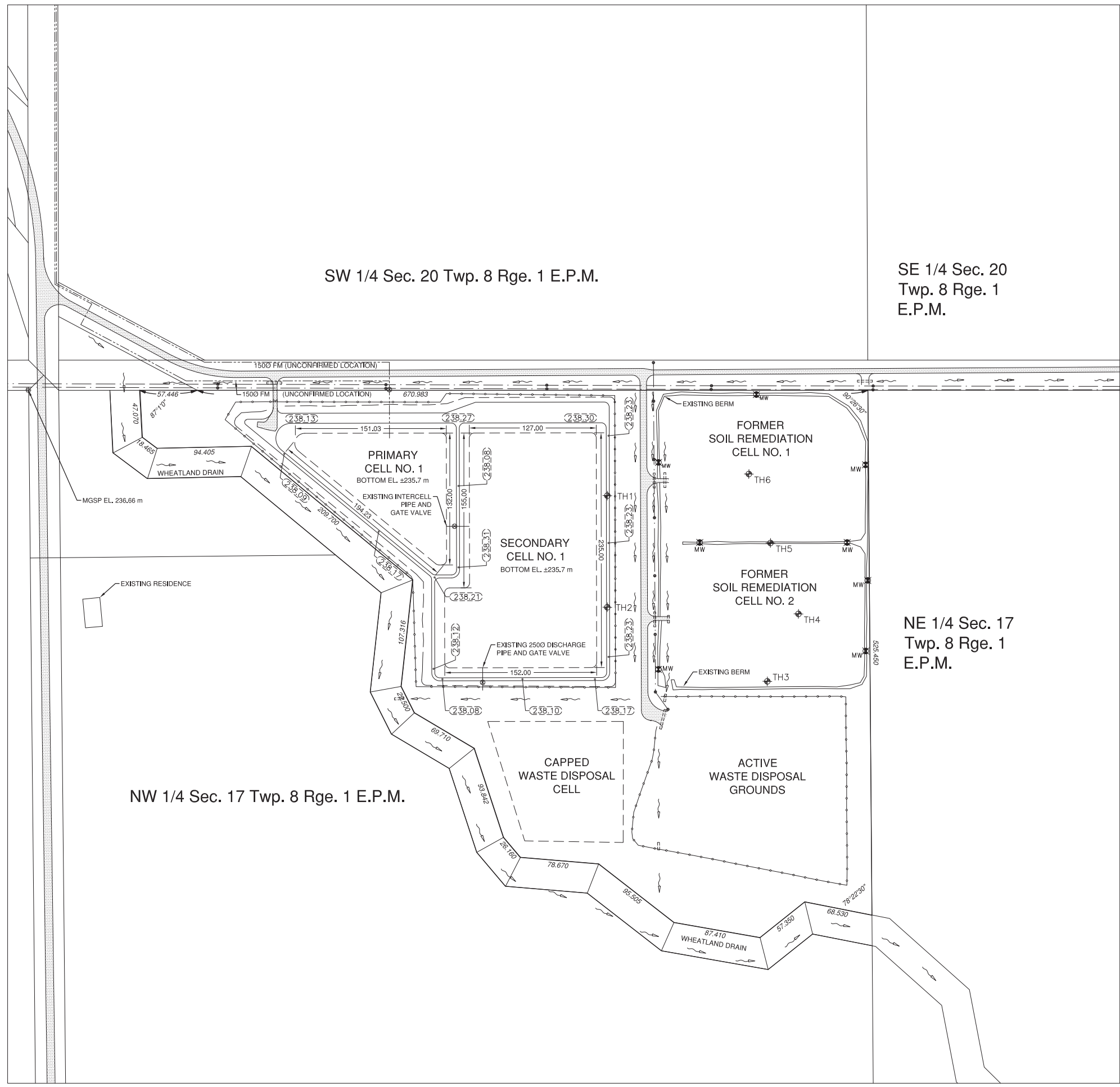

NOTES:

- LOCATION OF UNDERGROUND STRUCTURES AS SHOWN IS BASED ON THE BEST INFORMATION AVAILABLE, BUT NO GUARANTEE IS GIVEN THAT ALL EXISTING UTILITIES ARE SHOWN OR THAT THE GIVEN LOCATIONS ARE EXACT. CONFIRMATION OF EXISTENCE AND EXACT LOCATION OF ALL SERVICES MUST BE OBTAINED FROM THE INDIVIDUAL UTILITIES BEFORE PROCEEDING WITH CONSTRUCTION. THE CONTRACTOR SHALL NOTIFY THE CONSULTANT OF ANY ERROR OR OMISSION IN THE LOCATION OF ALL EXISTING UTILITIES SHOWN ON THE DRAWING.
- DESCRIPTION OF PROPERTY LIMITS, AND EXISTING AND/OR PROPOSED FEATURES RELATIVE TO THESE LIMITS AS SHOWN ON THIS DRAWING DO NOT REPRESENT A LEGAL SURVEY. WSP MAKES NO REPRESENTATION OR GUARANTEE THAT THE PROPERTY LIMIT INFORMATION IS ACCURATE. WSP ACCEPTS NO RESPONSIBILITY FOR DAMAGES, IF ANY, SUFFERED BY ANY THIRD PARTY AS A RESULT OF DECISIONS OR ACTIONS BASED ON THIS DRAWING.
- WHOLE NUMBERS INDICATE MILLIMETRES; DECIMALIZED NUMBERS INDICATE METRES



EXISTING	LEGEND	PROPOSED
---	WATERMAIN	---
---	WASTEWATER	---
---	LOW PRESSURE SEWER	---
---	FORCEMAIN	---
○	GATE VALVE	○
○	MANHOLE	○
○	HYDRANT	○
●	UTILITY POLE	●
—	GUY WIRE	—
⊗	MONITORING WELL	⊗
⊕	TESTHOLE LOCATION	⊕
⊠	HYDRO TOWER	⊠
▽	SIGN	▽
⊠	MTS PEDESTAL	⊠
⊠	SURVEY BAR	⊠
—	CLEAN OUT	—
---	CULVERT	---
---	DITCH / SWALE	---
---	TREE OR SHRUB LINE	---
---	FENCE LINE	---
---	HYDRO	---
---	GAS MAIN	---
---	MTS	---
---	DIRECTION OF FLOW	---
---	WICK DRAIN	---
---	RIP RAP	---
---	GROUND ELEVATION	---
---	DITCH ELEVATION	---
---	ROAD/DYKE ELEVATION	---
---	DYKE	---
---	EXISTING	---
---	LEGEND	---
---	PROPOSED	---

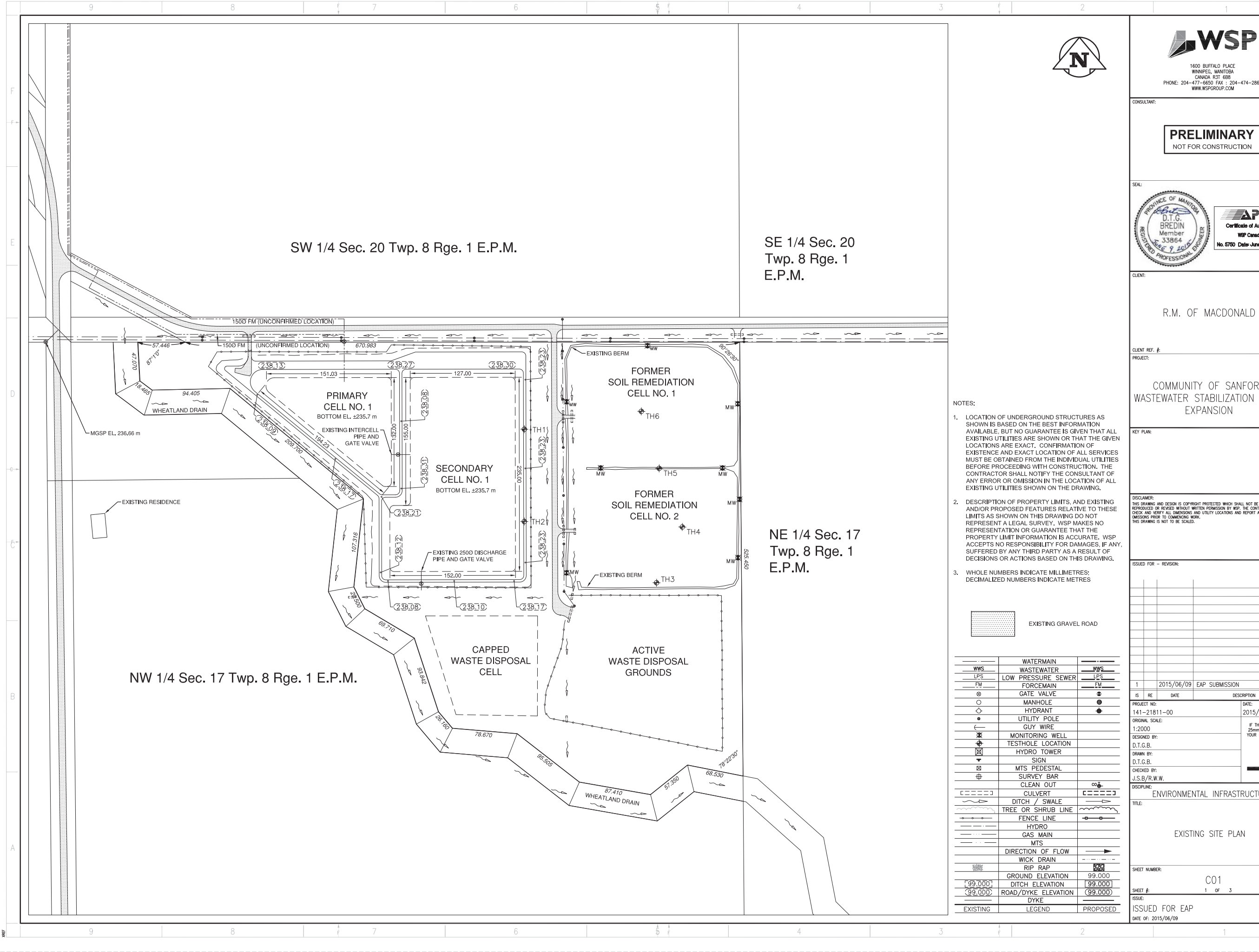



1600 BUFFALO PLACE
WINNIPEG, MANITOBA
CANADA R3T 6B8
PHONE: 204-477-6650 FAX: 204-474-2864
WWW.WSPGROUP.COM

CONSULTANT:

PRELIMINARY
NOT FOR CONSTRUCTION

SEAL:

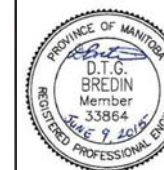

CLIENT:

R.M. OF MACDONALD

CLIENT REF. #:

PROJECT:

COMMUNITY OF SANFORD
WASTEWATER STABILIZATION POND
EXPANSION

KEY PLAN:

DISCLAIMER: THIS DRAWING AND DESIGN IS COPYRIGHT PROTECTED WHICH SHALL NOT BE USED, REPRODUCED OR REVISED WITHOUT WRITTEN PERMISSION BY WSP. THE CONTRACTOR SHALL CHECK AND VERIFY ALL DIMENSIONS AND UTILITY LOCATIONS AND REPORT ALL ERRORS AND OMISSIONS PRIOR TO COMMENCING WORK. THIS DRAWING IS NOT TO BE SCALED.

ISSUED FOR - REVISION:

1 2015/06/09 EAP SUBMISSION

IS	RE	DATE	DESCRIPTION

PROJECT NO: 141-21811-00 DATE: 2015/06/09

ORIGINAL SCALE: 1:1000 IF THIS BAR IS NOT 25mm LONG, ADJUST YOUR PLOTTING SCALE.

DESIGNED BY: D.T.G.B.

DRAWN BY: D.T.G.B.

CHECKED BY: J.S.B./R.W.W.

DISCIPLINE: ENVIRONMENTAL INFRASTRUCTURE

TITLE: PROPOSED SITE PLAN

SHEET NUMBER: C02

2 OF 3

ISSUE: ISSUED FOR EAP

DATE OF: 2015/06/09

REV # 0

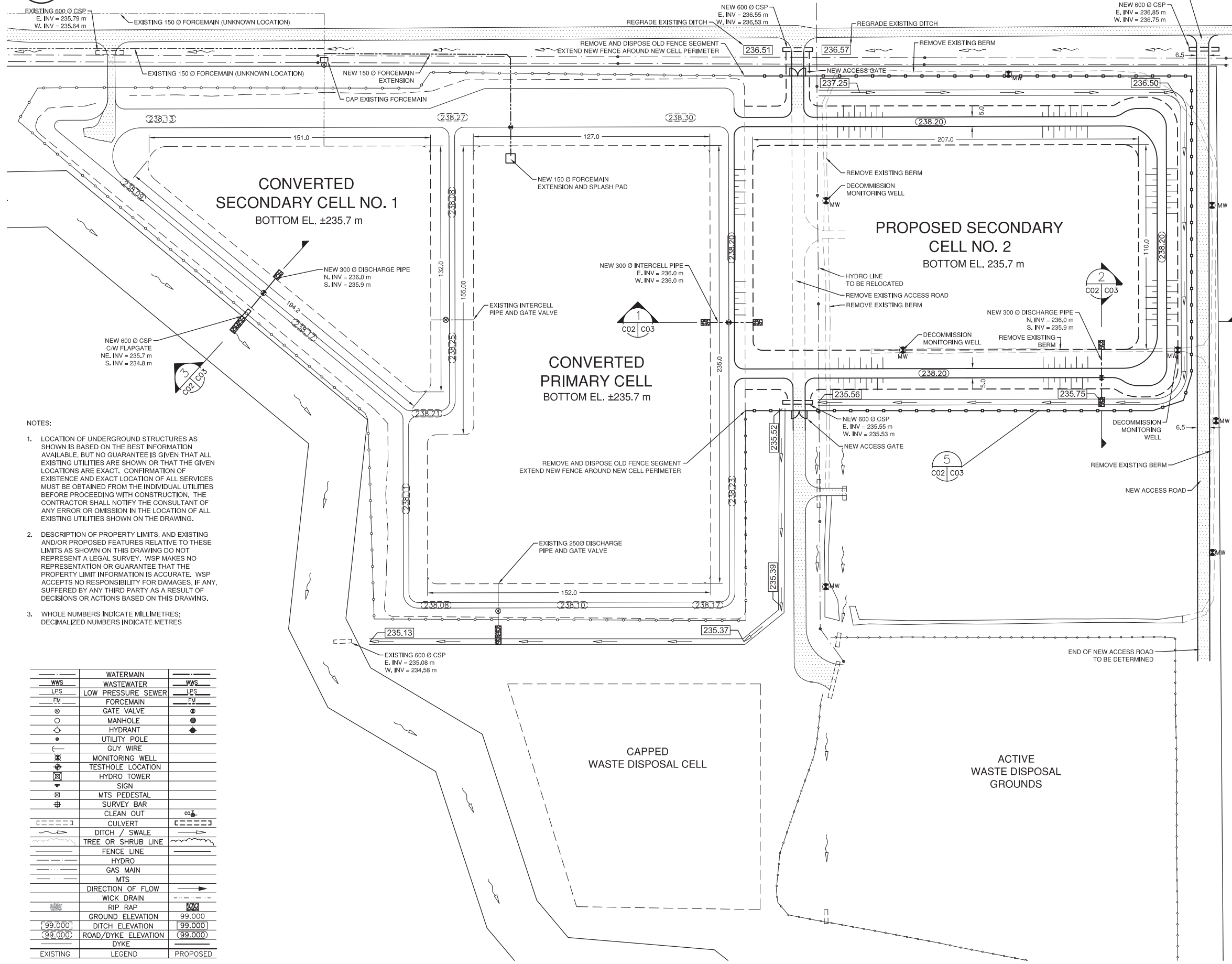

- NOTES:
- LOCATION OF UNDERGROUND STRUCTURES AS SHOWN IS BASED ON THE BEST INFORMATION AVAILABLE, BUT NO GUARANTEE IS GIVEN THAT ALL EXISTING UTILITIES ARE SHOWN OR THAT THE GIVEN LOCATIONS ARE EXACT. CONFIRMATION OF EXISTENCE AND EXACT LOCATION OF ALL SERVICES MUST BE OBTAINED FROM THE INDIVIDUAL UTILITIES BEFORE PROCEEDING WITH CONSTRUCTION. THE CONTRACTOR SHALL NOTIFY THE CONSULTANT OF ANY ERROR OR OMISSION IN THE LOCATION OF ALL EXISTING UTILITIES SHOWN ON THE DRAWING.
 - DESCRIPTION OF PROPERTY LIMITS, AND EXISTING AND/OR PROPOSED FEATURES RELATIVE TO THESE LIMITS AS SHOWN ON THIS DRAWING DO NOT REPRESENT A LEGAL SURVEY. WSP MAKES NO REPRESENTATION OR GUARANTEE THAT THE PROPERTY LIMIT INFORMATION IS ACCURATE. WSP ACCEPTS NO RESPONSIBILITY FOR DAMAGES, IF ANY, SUFFERED BY ANY THIRD PARTY AS A RESULT OF DECISIONS OR ACTIONS BASED ON THIS DRAWING.
 - WHOLE NUMBERS INDICATE MILLIMETRES; DECIMALIZED NUMBERS INDICATE METRES

WATERMAIN		WWS	
---	WASTEWATER	---	WWS
- - - -	LOW PRESSURE SEWER	- - - -	LPS
---	FORCEMAIN	---	FM
⊙	GATE VALVE	⊙	
○	MANHOLE	●	
⊕	HYDRANT	●	
•	UTILITY POLE	•	
—	GUY WIRE		
⊕	MONITORING WELL		
⊕	TESTHOLE LOCATION		
⊕	HYDRO TOWER		
⊕	SIGN		
⊕	MTS PEDESTAL		
⊕	SURVEY BAR		
⊕	CLEAN OUT		
---	CULVERT	---	
---	DITCH / SWALE	---	
---	TREE OR SHRUB LINE	---	
---	FENCE LINE	---	
---	HYDRO	---	
---	GAS MAIN	---	
---	MTS	---	
---	DIRECTION OF FLOW	---	
---	WICK DRAIN	---	
---	RIP RAP	---	
---	GROUND ELEVATION	---	99.000
---	DITCH ELEVATION	---	99.000
---	ROAD/DYKE ELEVATION	---	99.000
---	DYKE	---	
---	EXISTING	---	LEGEND
---		---	PROPOSED



1600 BUFFALO PLACE
WINNIPEG, MANITOBA
CANADA R3T 6B8
PHONE: 204-477-6650 FAX: 204-474-2864
WWW.WSPGROUP.COM

CONSULTANT:

PRELIMINARY
NOT FOR CONSTRUCTION

SEAL:

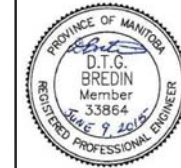

CLIENT:

R.M. OF MACDONALD

CLIENT REF. #:

PROJECT:

COMMUNITY OF SANFORD
WASTEWATER STABILIZATION POND
EXPANSION

KEY PLAN:

DISCLAIMER: THIS DRAWING AND DESIGN IS COPYRIGHT PROTECTED WHICH SHALL NOT BE USED, REPRODUCED OR REVISED WITHOUT WRITTEN PERMISSION BY WSP. THE CONTRACTOR SHALL CHECK AND VERIFY ALL DIMENSIONS AND UTILITY LOCATIONS AND REPORT ALL ERRORS AND OMISSIONS PRIOR TO COMMENCING WORK. THIS DRAWING IS NOT TO BE SCALED.

ISSUED FOR - REVISION:

1	2015/06/09	EAP SUBMISSION
---	------------	----------------

PROJECT NO:	141-21811-00	DATE:	2015/06/09
ORIGINAL SCALE:	N.T.S.	IF THIS BAR IS NOT 25mm LONG, ADJUST YOUR PLOTTING SCALE.	
DESIGNED BY:	D.T.G.B.		
DRAWN BY:	D.T.G.B.		
CHECKED BY:	J.S.B./R.W.W.		
DISCIPLINE:	ENVIRONMENTAL INFRASTRUCTURE		

TITLE:

CROSS SECTIONS AND DETAILS

SHEET NUMBER:

C03
3 OF 3

ISSUED FOR EAP
DATE OF: 2015/06/09

REV #
0

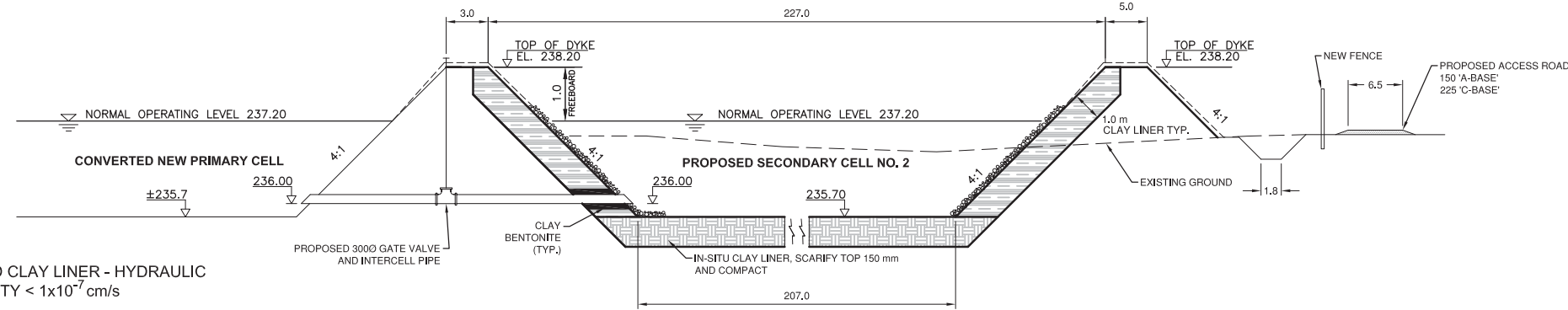

COMPACTED CLAY LINER - HYDRAULIC
CONDUCTIVITY <math>< 1 \times 10^{-7}</math> cm/s

INSITU CLAY LINER - HYDRAULIC
CONDUCTIVITY <math>< 1 \times 10^{-7}</math> cm/s

NOTE:
DYKE RIP RAP SHALL BE
PLACED TO A TOTAL WIDTH OF
7.5 METRES, STARTING AT THE
TOE AND EXTENDING UPWARD
ALONG THE INTERIOR SLOPE OF
THE DYKE

1 WEST-EAST SECTION OF COVERED PRIMARY CELL AND PROPOSED SECONDARY CELL
N.T.S.

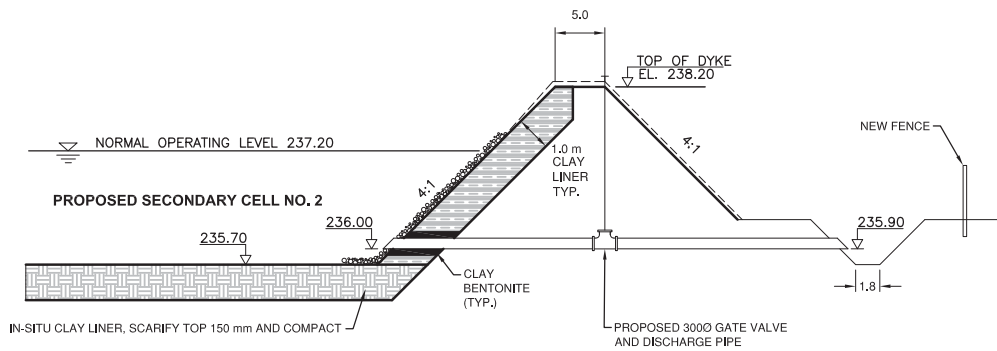

2 NORTH-SOUTH SECTION OF PROPOSED CELL
N.T.S.

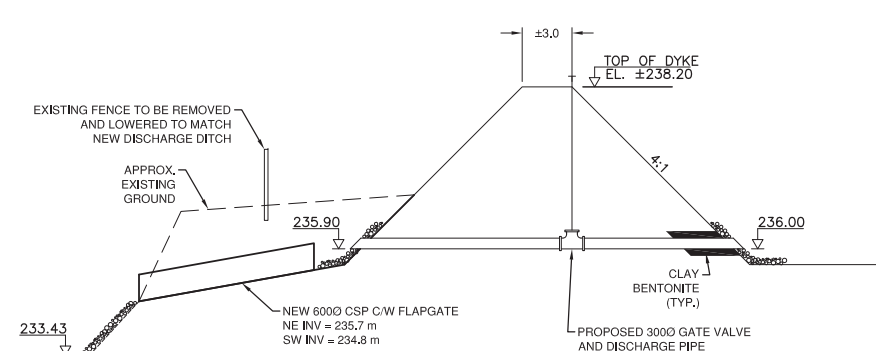

3 SOUTHWEST-NORTHEAST SECTION OF CONVERTED SECONDARY CELL
N.T.S.

750 x 900
DANGER
R.M. OF MACDONALD
WASTEWATER
STABILIZATION
FACILITY

PERIMETER FENCE SIGNAGE NOTES:
1) PERIMETER SIGNAGE TO BE SECURED TO PERIMETER FENCE POSTS
EVERY 50 m AROUND ENTIRE FACILITY
2) SIGNS TO BE CONSTRUCTED OF ALUMINUM, AIR MASTER QUALITY
OR APPROVED EQUAL



NOTES:

1. LOCATION OF UNDERGROUND STRUCTURES AS SHOWN IS BASED ON THE BEST INFORMATION AVAILABLE, BUT NO GUARANTEE IS GIVEN THAT ALL EXISTING UTILITIES ARE SHOWN OR THAT THE GIVEN LOCATIONS ARE EXACT. CONFIRMATION OF EXISTENCE AND EXACT LOCATION OF ALL SERVICES MUST BE OBTAINED FROM THE INDIVIDUAL UTILITIES BEFORE PROCEEDING WITH CONSTRUCTION. THE CONTRACTOR SHALL NOTIFY THE CONSULTANT OF ANY ERROR OR OMISSION IN THE LOCATION OF ALL EXISTING UTILITIES SHOWN ON THE DRAWING.
2. DESCRIPTION OF PROPERTY LIMITS, AND EXISTING AND/OR PROPOSED FEATURES RELATIVE TO THESE LIMITS AS SHOWN ON THIS DRAWING DO NOT REPRESENT A LEGAL SURVEY. WSP MAKES NO REPRESENTATION OR GUARANTEE THAT THE PROPERTY LIMIT INFORMATION IS ACCURATE. WSP ACCEPTS NO RESPONSIBILITY FOR DAMAGES, IF ANY, SUFFERED BY ANY THIRD PARTY AS A RESULT OF DECISIONS OR ACTIONS BASED ON THIS DRAWING.
3. WHOLE NUMBERS INDICATE MILLIMETRES; DECIMALIZED NUMBERS INDICATE METRES

NOTES:

1. CORNER POSTS: 175Ø TREATED WOOD POST, 2400mm LONG
2. REGULAR POSTS: 125Ø TREATED WOOD POST, 2100mm LONG
3. 2 STRAND 2Ø GALVANIZED WIRE (TYP.)
4. WIRE FENCE STAPLES (TYP.)
5. 4 POINT BARBS (TYP.)

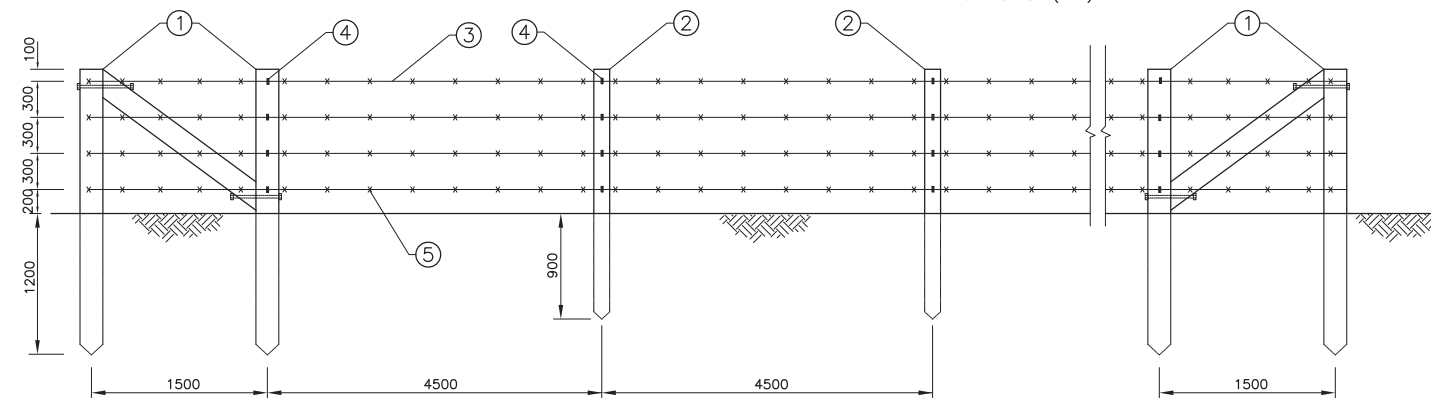

5 PERIMETER FENCE DETAIL
N.T.S.

Appendix E

GENERAL CORRESPONDENCE FOR REFERENCE

Bredin, Dana

From: Smith, Brian (TCHSCP) <Brian.Smith@gov.mb.ca>
Sent: May-11-15 11:40 AM
To: Bredin, Dana
Cc: Nesbitt, Christina (TCHSCP)
Subject: Heritage Resources Information request RM of Macdonald EAP lagoon expansion

Dana,

Historic Resources Branch had reviewed the area referred to in your email of April 8, 2015 regarding the expansion of the lagoon located in NW 17-8-1 EPM and has determined the project as described has low potential to impact heritage resources, therefore we have no heritage concerns with the project as proposed. However, if significant heritage resources or human remains are encountered during any phase of development the Historic Resources Branch is to be contacted immediately.

Brian J. Smith
Manager, Archaeological Assessment Services Unit
Historic Resources Branch
213 Notre Dame Avenue, Winnipeg, MB R3B 1N3
Phone (204) 945-1830; Fax (204) 948-2384
E-mail: Brian.Smith@gov.mb.ca

Bredin, Dana

From: Little, Karen (CLPA) <Karen.Little@gov.mb.ca>
Sent: April-20-15 1:17 PM
To: Bredin, Dana
Subject: RE: Mineral Rights Information Request [WSP# 141-21811-00]

Good afternoon Dana – according to our records this date:

- S ½ of NW 17-8-1 EPM - The Dominion of Canada granted this part section to George Deschambault Jr in October 1881 along with the mines & minerals and sand & gravel.
- N ½ of NW 17-8-1 EPM – The Dominion of Canada granted this part section to Bruce Frederick in February 1881 along with the mines & minerals and sand & gravel.

The Province acquired Public Plan 15508 WLTO in NW 17-8-1 EPM and has ownership of the mines & minerals and sand & gravel. The Province does not own the mines & minerals and sand & Gravel in the balance of the NW 17-8-1 EPM.

Sincerely,

Karen Little

Supervisor of Crown Lands Registry

Crown Lands and Property Agency
308 - 25 Tupper Street North
Portage la Prairie MB R1N 3K1
P 204-239-3805 F 204-239-3560
Toll Free 1-866-210-9589
karen.little@gov.mb.ca



An Agency of the Manitoba Government

The information contained in this e-mail and all attachments is confidential and is for the sole use of its intended recipient. It may not be disclosed to or used by anyone other than the addressee. If received in error, please contact the sender by return e-mail and delete this e-mail and all attachments from your system.

Le présent courrier électronique (courriel) et les documents qui y sont attachés peuvent contenir de l'information confidentielle; ils s'adressent exclusivement au destinataire mentionné ci-dessus et nulle autre personne ne doit en prendre connaissance ni les utiliser ou les divulguer. Si vous recevez le présent courriel par erreur, veuillez en aviser l'émetteur immédiatement par courrier électronique et le détruire avec les documents qui y sont attachés.

From: Bredin, Dana [mailto:Dana.Bredin@wspgroup.com]
Sent: April-16-15 9:37 AM
To: Little, Karen (CLPA)
Cc: CA - WinnipegFiling
Subject: Mineral Rights Information Request [WSP# 141-21811-00]

Hi Karen,

I'm preparing an Environment Act Proposal for the R.M. of Macdonald and require the mineral rights (Mines and Minerals, and Sand and Gravel) for NW 1/4 Sec. 17-8-1 EPM. The Status of Title (1289566) is silent on the Mines and Minerals. I would greatly appreciate any information you can provide before April 30.

Regards,



Dana Bredin, P.Eng
Geotechnical / Civil Engineer

WSP Canada Inc.
1600 Buffalo Place
Winnipeg, Manitoba R3T 6B8
T 204-477-6650 ext.373 | F 204-474-2864 | C 204-479-0014
www.wspgroup.com

Please consider the environment before printing...

You are receiving this communication because you are listed as a current WSP contact. Should you have any questions regarding WSP's electronic communications policy, please consult our Anti-Spam Commitment www.wspgroup.com/casl or contact us at caslcompliance@wspgroup.com.
CONFIDENTIALITY WARNING

This message is intended only for the use of the individual or entity to which it is addressed, and may contain information which is privileged, confidential, proprietary or exempt from disclosure under applicable law. If you are not the intended recipient or the person responsible for delivering the message to the intended recipient, you are strictly prohibited from disclosing, distributing, copying or in any way using this message. If you have received this communication in error, please notify the sender, and destroy and delete any copies you may have received.

Vous recevez cette communication car vous faites partis des contacts de WSP. Si vous avez des questions concernant la politique de communications électroniques de WSP, veuillez consulter notre Engagement anti-pourriel www.wspgroup.com/lcap ou contactez-nous au conformitelcap@wspgroup.com.
AVERTISSEMENT

Ce message est destiné uniquement à la personne ou à l'organisation à laquelle il est adressé et il peut contenir des informations privilégiées, confidentielles ou non divulguables en vertu de la loi. Si vous n'êtes pas le destinataire du présent message ni la personne chargée de remettre le présent message à son destinataire, il vous est strictement interdit de le divulguer, de le distribuer, de le copier ou de l'utiliser de quelque façon que ce soit. Si vous avez reçu la présente communication par erreur, veuillez en aviser l'expéditeur et détruire ou effacer tous les exemplaires que vous avez reçus.

Bredin, Dana

From: Friesen, Chris (CWS) <Chris.Friesen@gov.mb.ca>
Sent: May-29-15 1:08 PM
To: Bredin, Dana
Cc: CA - WinnipegFiling
Subject: RE: Rare Species Request - NW 17-8-1 EPM [WSP#141-21811-00]

Dana

Thank you for your information request. I completed a search of the Manitoba Conservation Data Centre's rare species database and found no occurrences at this time for your area of interest.

The information provided in this letter is based on existing data known to the Manitoba Conservation Data Centre at the time of the request. These data are dependent on the research and observations of CDC staff and others who have shared their data, and reflect our current state of knowledge. **An absence of data in any particular geographic area does not necessarily mean that species or ecological communities of concern are not present;** in many areas, comprehensive surveys have never been completed. Therefore, this information should be regarded neither as a final statement on the occurrence of any species of concern, nor as a substitute for on-site surveys for species as part of environmental assessments.

Because the Manitoba CDC's Biotics database is continually updated and because information requests are evaluated by type of action, any given response is only appropriate for its respective request. Please contact the Manitoba CDC for an update on this natural heritage information if more than six months pass before it is utilized.

Third party requests for products wholly or partially derived from Biotics must be approved by the Manitoba CDC before information is released. Once approved, the primary user will identify the Manitoba CDC as data contributors on any map or publication using Biotics data, as follows as: Data developed by the Manitoba Conservation Data Centre; Wildlife Branch, Manitoba Conservation and Water Stewardship.

This letter is for information purposes only - it does not constitute consent or approval of the proposed project or activity, nor does it negate the need for any permits or approvals required by the Province of Manitoba.

We would be interested in receiving a copy of the results of any field surveys that you may undertake, to update our database with the most current knowledge of the area.

If you have any questions or require further information please contact me directly at (204) 945-7747.

Chris Friesen
Coordinator
Manitoba Conservation Data Centre
204-945-7747
chris.friesen@gov.mb.ca
<http://www.gov.mb.ca/conservation/cdc/>

From: Bredin, Dana [mailto:Dana.Bredin@wspgroup.com]
Sent: May-20-15 9:18 AM
To: Friesen, Chris (CWS)
Cc: CA - WinnipegFiling
Subject: Rare Species Request - NW 17-8-1 EPM [WSP#141-21811-00]

Hi Chris,

I'm preparing an Environment Act Proposal for the RM of Macdonald regarding a lagoon expansion. The lagoon and expansion are located within NW 17-8-1 EPM. Please provide a listing of rare species for the identified area. It would be greatly appreciated if I received your information before May 29.

Regards,



Dana Bredin, P.Eng
Geotechnical / Civil Engineer

WSP Canada Inc.
1600 Buffalo Place
Winnipeg, Manitoba R3T 6B8
T 204-477-6650 ext.373 | F 204-474-2864 | C 204-479-0014
www.wspgroup.com

Please consider the environment before printing...

You are receiving this communication because you are listed as a current WSP contact. Should you have any questions regarding WSP's electronic communications policy, please consult our Anti-Spam Commitment www.wspgroup.com/cas or contact us at caslcompliance@wspgroup.com.
CONFIDENTIALITY WARNING

This message is intended only for the use of the individual or entity to which it is addressed, and may contain information which is privileged, confidential, proprietary or exempt from disclosure under applicable law. If you are not the intended recipient or the person responsible for delivering the message to the intended recipient, you are strictly prohibited from disclosing, distributing, copying or in any way using this message. If you have received this communication in error, please notify the sender, and destroy and delete any copies you may have received.

Vous recevez cette communication car vous faites partis des contacts de WSP. Si vous avez des questions concernant la politique de communications électroniques de WSP, veuillez consulter notre Engagement anti-pourriel www.wspgroup.com/lcap ou contactez-nous au conformitelcap@wspgroup.com.
AVERTISSEMENT

Ce message est destiné uniquement à la personne ou à l'organisation à laquelle il est adressé et il peut contenir des informations privilégiées, confidentielles ou non divulguables en vertu de la loi. Si vous n'êtes pas le destinataire du présent message ni la personne chargée de remettre le présent message à son destinataire, il vous est strictement interdit de le divulguer, de le distribuer, de le copier ou de l'utiliser de quelque façon que ce soit. Si vous avez reçu la présente communication par erreur, veuillez en aviser l'expéditeur et détruire ou effacer tous les exemplaires que vous avez reçus.

Bredin, Dana

From: Matthews, Rob (CWS) <Rob.Matthews@gov.mb.ca>
Sent: April-08-15 4:50 PM
To: Bredin, Dana
Cc: McCombe, Christopher (CWS)
Subject: RE: Licensed Water Users Information Request [WSP# 141-21811-00]

Thanks,

So the WTP at Sanford is upstream and it is the only WTP on the La Salle from that point to the mouth of the La Salle.

There will be at a few irrigation use licences downstream from that point serving golf courses.

Rob

From: Bredin, Dana [mailto:Dana.Bredin@wspgroup.com]
Sent: April-08-15 4:40 PM
To: Matthews, Rob (CWS)
Subject: RE: Licensed Water Users Information Request [WSP# 141-21811-00]

Hi Rob,

I've attached a larger photo showing the location of Sanford relative to the lagoon. Sanford is approximately 1 mile north/northwest of the lagoon. Please let me know if you require more information.

Thanks,
Dana

From: Matthews, Rob (CWS) [mailto:Rob.Matthews@gov.mb.ca]
Sent: Wednesday, April 08, 2015 4:26 PM
To: Bredin, Dana
Subject: RE: Licensed Water Users Information Request [WSP# 141-21811-00]

Dana,

Is Sanford located on your map?

Rob Matthews

From: Bredin, Dana [mailto:Dana.Bredin@wspgroup.com]
Sent: April-08-15 2:05 PM
To: Matthews, Rob (CWS)
Cc: CA - WinnipegFiling
Subject: Licensed Water Users Information Request [WSP# 141-21811-00]

Hi Rob,

I'm preparing an Environment Act Proposal for the R.M. of Macdonald regarding the expansion of their existing lagoon located in NW 17-8-1 EPM, near Sanford. The lagoon discharges by piped flow into a discharge ditch, which flows east towards the La Salle River. Please provide the licensed water users within ~1 km upstream and ~10 km downstream of

the discharge point into the La Salle River. I've attached a map for your convenience. I would greatly appreciate your information before April 20.

Regards,



Dana Bredin, P.Eng
Geotechnical / Civil Engineer

WSP Canada Inc.
1600 Buffalo Place
Winnipeg, Manitoba R3T 6B8
T 204-477-6650 ext.373 | F 204-474-2864 | C 204-479-0014
www.wspgroup.com

Please consider the environment before printing...

You are receiving this communication because you are listed as a current WSP contact. Should you have any questions regarding WSP's electronic communications policy, please consult our Anti-Spam Commitment www.wspgroup.com/casl or contact us at caslcompliance@wspgroup.com.

CONFIDENTIALITY WARNING

This message is intended only for the use of the individual or entity to which it is addressed, and may contain information which is privileged, confidential, proprietary or exempt from disclosure under applicable law. If you are not the intended recipient or the person responsible for delivering the message to the intended recipient, you are strictly prohibited from disclosing, distributing, copying or in any way using this message. If you have received this communication in error, please notify the sender, and destroy and delete any copies you may have received.

Vous recevez cette communication car vous faites partis des contacts de WSP. Si vous avez des questions concernant la politique de communications électroniques de WSP, veuillez consulter notre Engagement anti-pourriel www.wspgroup.com/lcap ou contactez-nous au conformitelcap@wspgroup.com.

AVERTISSEMENT

Ce message est destiné uniquement à la personne ou à l'organisation à laquelle il est adressé et il peut contenir des informations privilégiées, confidentielles ou non divulguables en vertu de la loi. Si vous n'êtes pas le destinataire du présent message ni la personne chargée de remettre le présent message à son destinataire, il vous est strictement interdit de le divulguer, de le distribuer, de le copier ou de l'utiliser de quelque façon que ce soit. Si vous avez reçu la présente communication par erreur, veuillez en aviser l'expéditeur et détruire ou effacer tous les exemplaires que vous avez reçus.

You are receiving this communication because you are listed as a current WSP contact. Should you have any questions regarding WSP's electronic communications policy, please consult our Anti-Spam Commitment www.wspgroup.com/casl or contact us at caslcompliance@wspgroup.com.

CONFIDENTIALITY WARNING

This message is intended only for the use of the individual or entity to which it is addressed, and may contain information which is privileged, confidential, proprietary or exempt from disclosure under applicable law. If you are not the intended recipient or the person responsible for delivering the message to the intended recipient, you are strictly prohibited from disclosing, distributing, copying or in any way using this message. If you have received this communication in error, please notify the sender, and destroy and delete any copies you may have received.

Vous recevez cette communication car vous faites partis des contacts de WSP. Si vous avez des questions concernant la politique de communications électroniques de WSP, veuillez consulter notre Engagement anti-pourriel www.wspgroup.com/lcap ou contactez-nous au conformitelcap@wspgroup.com.

AVERTISSEMENT

Ce message est destiné uniquement à la personne ou à l'organisation à laquelle il est adressé et il peut contenir des informations privilégiées, confidentielles ou non divulguables en vertu de la loi. Si vous n'êtes pas le destinataire du présent message ni la personne chargée de remettre le présent message à son destinataire, il vous est strictement interdit de le divulguer, de le distribuer, de le copier ou de l'utiliser de quelque façon que ce soit. Si vous avez reçu la présente communication par erreur, veuillez en aviser l'expéditeur et détruire ou effacer tous les exemplaires que vous avez reçus.

Bredin, Dana

From: Matthews, Rob (CWS) <Rob.Matthews@gov.mb.ca>
Sent: April-13-15 11:57 AM
To: Bredin, Dana
Subject: FW: Licensed Water Users Information Request [WSP# 141-21811-00]
Attachments: Water_Use_Lic_Near_NW17-8-1E.xlsx

Dana,

Attached is the response to your request.

Apparently there is one municipal use downstream.

Rob

From: McCombe, Christopher (CWS)
Sent: April-13-15 11:54 AM
To: Matthews, Rob (CWS)
Subject: RE: Licensed Water Users Information Request [WSP# 141-21811-00]

Rob,

Please see attached excel doc showing all (2) licensed water users within ~10 km downstream of the discharge point into the La Salle River (there are none within ~1km upstream).

Please forward to Dana when you see fit.

Thanks,

Christopher McCombe

From: Matthews, Rob (CWS)
Sent: April-08-15 4:52 PM
To: McCombe, Christopher (CWS)
Subject: FW: Licensed Water Users Information Request [WSP# 141-21811-00]

Chris,

Note the previous two related emails on this matter.

Rob

From: Bredin, Dana [<mailto:Dana.Bredin@wspgroup.com>]
Sent: April-08-15 2:05 PM
To: Matthews, Rob (CWS)
Cc: CA - WinnipegFiling
Subject: Licensed Water Users Information Request [WSP# 141-21811-00]

Hi Rob,

I'm preparing an Environment Act Proposal for the R.M. of Macdonald regarding the expansion of their existing lagoon located in NW 17-8-1 EPM, near Sanford. The lagoon discharges by piped flow into a discharge ditch, which flows east towards the La Salle River. Please provide the licensed water users within ~1 km upstream and ~10 km downstream of the discharge point into the La Salle River. I've attached a map for your convenience. I would greatly appreciate your information before April 20.

Regards,



Dana Bredin, P.Eng
Geotechnical / Civil Engineer

WSP Canada Inc.
1600 Buffalo Place
Winnipeg, Manitoba R3T 6B8
T 204-477-6650 ext.373 | F 204-474-2864 | C 204-479-0014
www.wspgroup.com

Please consider the environment before printing...

You are receiving this communication because you are listed as a current WSP contact. Should you have any questions regarding WSP's electronic communications policy, please consult our Anti-Spam Commitment www.wspgroup.com/casl or contact us at caslcompliance@wspgroup.com.

CONFIDENTIALITY WARNING

This message is intended only for the use of the individual or entity to which it is addressed, and may contain information which is privileged, confidential, proprietary or exempt from disclosure under applicable law. If you are not the intended recipient or the person responsible for delivering the message to the intended recipient, you are strictly prohibited from disclosing, distributing, copying or in any way using this message. If you have received this communication in error, please notify the sender, and destroy and delete any copies you may have received.

Vous recevez cette communication car vous faites partis des contacts de WSP. Si vous avez des questions concernant la politique de communications électroniques de WSP, veuillez consulter notre Engagement anti-pourriel www.wspgroup.com/lcap ou contactez-nous au conformitelcap@wspgroup.com.

AVERTISSEMENT

Ce message est destiné uniquement à la personne ou à l'organisation à laquelle il est adressé et il peut contenir des informations privilégiées, confidentielles ou non divulguables en vertu de la loi. Si vous n'êtes pas le destinataire du présent message ni la personne chargée de remettre le présent message à son destinataire, il vous est strictement interdit de le divulguer, de le distribuer, de le copier ou de l'utiliser de quelque façon que ce soit. Si vous avez reçu la présente communication par erreur, veuillez en aviser l'expéditeur et détruire ou effacer tous les exemplaires que vous avez reçus.

TWP. 10

R. M. OF CARTIER
R. M. OF MACDONALD

TWP. 9

TWP. 8

TWP. 7

R. M. OF MACDONALD
R. M. OF MORRIS

SANFORD LAGOON

INFLOW FROM
KING DRAIN
W. S. NO. 20

RGE. 1W.

RGE. 1E.

RGE. 2E.

RGE. 3E.

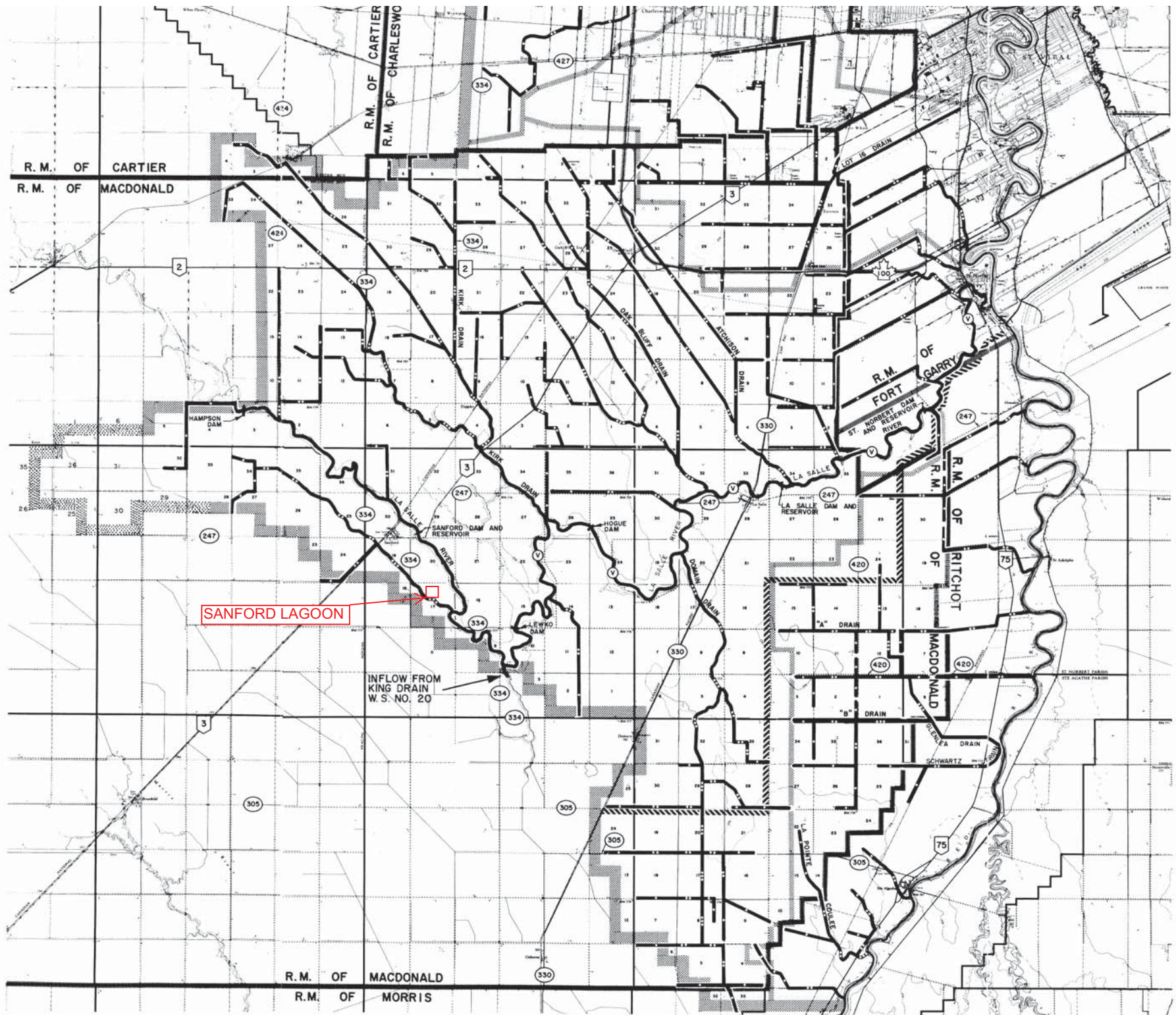

Draft Data - Subject to ongoing review

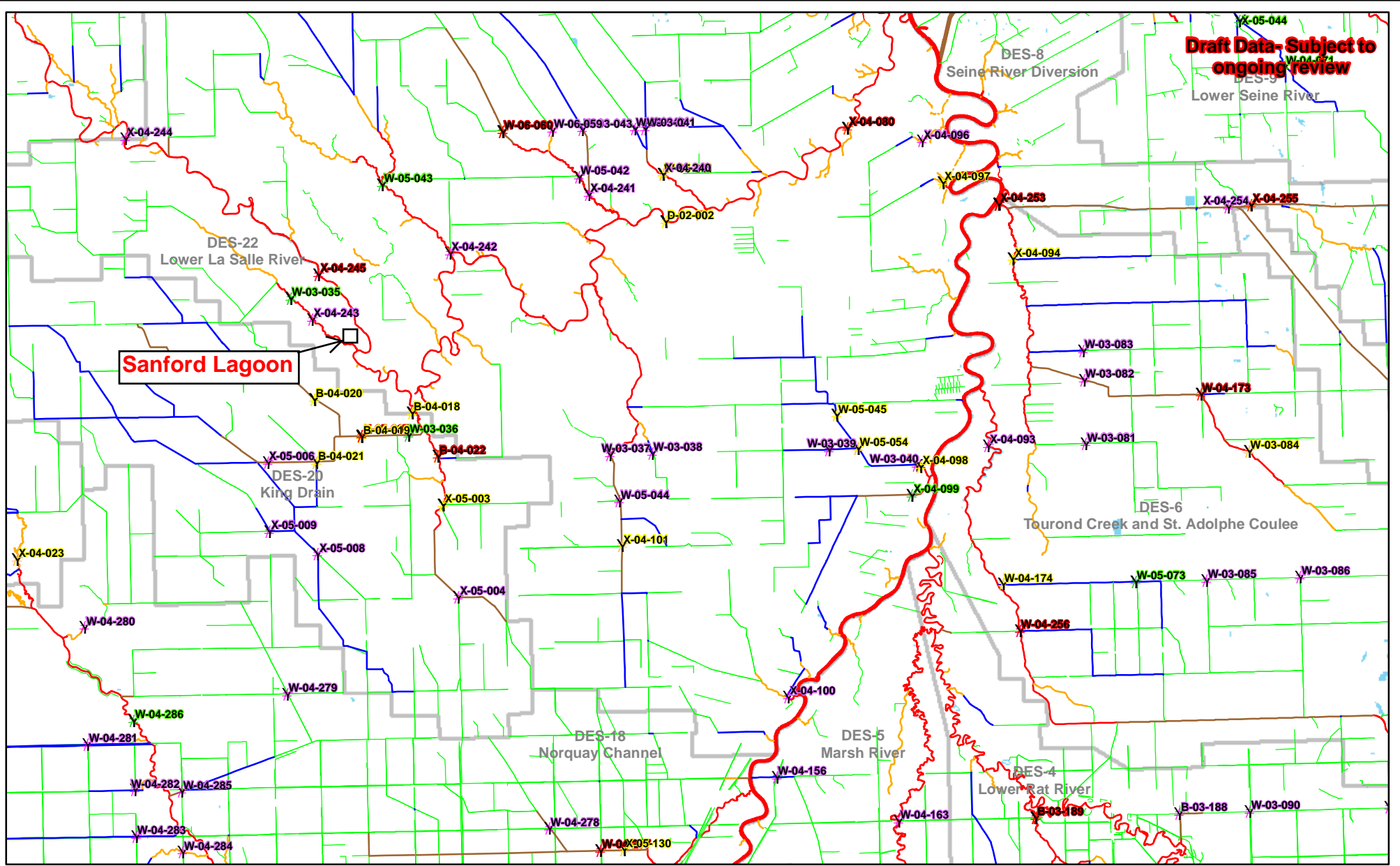

Sanford Lagoon

062H13	062H14	062H15
062H12	062H11	062H10
062H05	062H06	062H07

Habitat Classification

- A
- B
- C
- D
- E

Fishing Results

- Indicator Species
- Non-Indicator Species
- No Catch
- No Fishing Effort

Appendix 9
Sampling sites, fish captures and habitat classification
of streams and constructed drains throughout
agricultural areas of Manitoba (2002 – 2006)

062H11

Produced April 2012

Macdonald-Ritchot Planning District

Development Plan
BY-LAW No. 2-2010

MAP 4

Sanford

By-Law 2-10 Designations

- GZ - Green/Agricultural Policy Area
- RC - Rural Centre Policy Area
- RCH - Rural Centre Hold Policy Area
- UC - Urban Centre Policy Area
- UCH - Urban Centre Hold Policy Area
- EC - Enterprise Centre Policy Area
- ECH - Enterprise Centre Hold Policy Area
- EV - Environmental Policy Area
- Flood Protection Dike
- Municipal Boundary

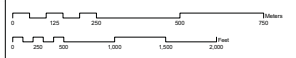

Originally Created By:
 Lombard North Group (1984) Ltd.

Modified By:
 Manitoba
Local Government
Community Planning Services

Source: Manitoba Land Initiative, 2011

