

**Comprehensive Report of Vale Canada Limited**

**Manitoba Operations**

**August 6<sup>th</sup> , 2015**

**Submitted to: Jennifer Winsor, P.Eng.**

**Environmental Engineer**

**Environmental Approvals Branch**

**Conservation and Water Stewardship**

**123 Main St., Suite. 160**

**Winnipeg, MB R3C 1A5**

**Submitted by: Donal S Allen, P.Eng.**

**Vale Canada Limited – Manitoba Operations**

**Thompson, MB**



|  |           |
|--|-----------|
| <b>Background .....</b>  | <b>6</b>  |
| <b>Section 1 Introduction .....</b>                                      | <b>7</b>  |
| <b>1.1 Site Location.....</b>  | <b>7</b>  |
| <b>1.2 Land Use .....</b>  | <b>7</b>  |
| <b>1.3 Topography .....</b>  | <b>7</b>  |
| <b>1.4 Regional Geology.....</b>   | <b>8</b>  |
| <b>1.5 Description of Vale Canada Limited – Manitoba Operations.....</b> | <b>8</b>  |
| <b>1.6 Summary of Process.....</b>                                       | <b>11</b> |
| <b>Section 2 Operational Sites .....</b>                                 | <b>14</b> |
| <b>2.1 Thompson Open Pit .....</b>                                       | <b>15</b> |
| <b>2.3 Gravel Quarry .....</b>   | <b>17</b> |
| <b>2.4 Birchtree Mine .....</b>  | <b>17</b> |
| <b>2.5 Thompson Mine.....</b>  | <b>22</b> |
| <b>2.6 Mill .....</b>  | <b>27</b> |
| <b>Crushing .....</b>  | <b>30</b> |
| <b>Crushing Circuit Operation .....</b>                                  | <b>31</b> |
| <b>Production and Quality Measurements .....</b>                         | <b>33</b> |
| <b>Grinding Circuit Operation .....</b>                                  | <b>33</b> |
| <b>Production and Quality Measurements.....</b>                          | <b>34</b> |
| <b>Flotation.....</b>  | <b>35</b> |
| <b>Rougher Cleaner Circuit .....</b>                                     | <b>36</b> |
| <b>Regrind Circuit.....</b>  | <b>36</b> |
| <b>Scavenger Circuit.....</b>  | <b>36</b> |
| <b>Scavenger Cleaner/Re-Cleaner Circuit .....</b>                        | <b>37</b> |
| <b>Copper/Nickel Separation Circuit.....</b>                             | <b>37</b> |
| <b>Copper/Nickel Separators.....</b>                                     | <b>37</b> |
| <b>Copper Cleaners .....</b>   | <b>37</b> |

|  |           |
|--|-----------|
| <b>2.7 Smelter</b> .....                                     | <b>40</b> |
| <b>2.9 Utilities &amp; Water Infrastructure</b> .....        | <b>55</b> |
| <b>2.10.1 Site Security</b> .....                            | <b>60</b> |
| <b>2.10.2 General Office</b> .....                           | <b>60</b> |
| <b>2.10.3 Maintenance Shops</b> .....                        | <b>60</b> |
| <b>2.10.4 Warehouse and Traffic</b> .....                    | <b>60</b> |
| <b>2.10.5 Fire Hall and Transportation</b> .....             | <b>60</b> |
| <b>2.10.6 Valer Building</b> .....                           | <b>60</b> |
| <b>2.10.7 Surface Dry</b> .....                              | <b>60</b> |
| <b>2.10.8 Thaw Shed/Copper Concentrate Tents</b> .....       | <b>60</b> |
| <b>2.10.9 Haulage Contractor on Site Building</b> .....      | <b>62</b> |
| <b>2.10.10 Orica Operations</b> .....                        | <b>63</b> |
| <b>2.11 Transportation and Logistic</b> .....                | <b>66</b> |
| <b>Section 3 Waste Treatment and Control</b> .....           | <b>68</b> |
| <b>3.1 Waste Management Facility</b> .....                   | <b>69</b> |
| <b>3.2 Tailings Management Area</b> .....                    | <b>74</b> |
| <b>3.3 Water Management Flow</b> .....                       | <b>80</b> |
| <b>3.4 Emissions and Air Quality Programs Overview</b> ..... | <b>83</b> |
| <b>Section 4 Decommissioned/Inactive Sites</b> .....         | <b>86</b> |
| <b>4.1 Moak Lake (Decommissioned)</b> .....                  | <b>87</b> |
| <b>4.2 SOAB North (Decommissioned)</b> .....                 | <b>87</b> |
| <b>4.3 SOAB South (Decommissioned)</b> .....                 | <b>88</b> |
| <b>4.4 Pipe Mine (Care and Maintenance)</b> .....            | <b>88</b> |
| <b>Section 5 Appendices</b> .....                            | <b>90</b> |
| <b>Appendix 1 - Thompson Site Plan</b> .....                 | <b>90</b> |

|  |           |
|--|-----------|
| <b>Appendix 2 - Operations Flow Sheet .....</b>                                      | <b>90</b> |
| <b>Appendix 3 - Station B, Weir and BT Effluent Discharge results for 2014 .....</b> | <b>90</b> |
| <b>Appendix 4 - 42” and 48” Sewer Schematic .....</b>                                | <b>90</b> |
| <b>Appendix 5 - 2014 NPRI substance &amp; GHG reports .....</b>                      | <b>90</b> |

## **Background**

This report is being submitted to Environmental Approvals Branch Conservation and Water Stewardship in response to the Notice of Alteration relating to Dam B modifications (File No 557.10). Dam B along with several other dams on the site are being raised to ensure sufficient containment and management capacity for continued safe mining operation and closure of the Thompson Facility. This report is in response to the email correspondence between the Environmental Approvals Branch and Vale Canada Limited – Manitoba Division personnel between May 11<sup>th</sup>, 2015 and June 8<sup>th</sup>, 2015. The context of said emails requested:

*“Comprehensive report and site plan, we are looking at Vale’s mining operations as a whole. We would like the submission to include a site plan showing the locations of Vale’s infrastructure as well as a report which includes process flow diagrams and a description of all waste streams at the development. The submission format should be one comprehensive report/package and should provide enough detail that someone could review the information and clearly understand the mining operations at Vale.”*

## **Section 1 Introduction**

### **1.1 Site Location**

The Thompson Mine is situated in Thompson, Manitoba, at latitude 55° 48' N and longitude 97° 52' W. Thompson Mine is located approximately 5 km (3 miles) south of the City of Thompson, and approximately 645 km (400 miles) north of Winnipeg, Manitoba.

### **1.2 Land Use**

The Thompson mine area is approximately 5,400 ha (13,345 acres) of which the plant site area only comprises about 100 ha (247 acres). The mine site was originally a native boreal forest with bogs and lakes.

The site is a fully integrated mining and processing facility having a nominal capacity in excess of 50 million kgs (100 million lbs) per year of pure nickel. Minimal quantities of copper, cobalt and precious metals are also recovered. Vale has operated a number of open pit and underground mines on the 13 km wide by 97 km long (8 mile wide by 60 mile long) Thompson Nickel Belt since the operations were first commissioned in the late 1950's. An overall plan view of the Thompson site is presented as part of this submission.

All the necessary infrastructure to support a large mining operation is provided onsite including utilities, shops, warehouses, offices and laboratories.

### **1.3 Topography**

The Thompson area is situated in the Kazan Upland Division of the Canadian Shield. This physiographic division is a heavily glaciated area of ancient Precambrian rocks. The division is underlain by dominantly granitic and gneissic bedrock, interspersed with numerous belts of highly folded and metamorphosed volcanic and sedimentary rocks. The relief is gentle with elevations varying from 180 m to 240 m (545 ft to 730 ft) above mean sea level (AMSL).

The topography varies from nearly level to rolling, with undulating and hummocky terrain being most common, and is mainly controlled by bedrock. However, a thick mantle of lacustrine clays subdues the bedrock relief to a great extent. Topography is further subdued by the development of organic landforms (bogs and fens) in depressions and on gentle slopes and the drainage pattern is, in general, poorly defined. The vegetation in the area consists of stunted trees and low brush.

Lakes of various sizes are common in the area. Major rivers include the Burntwood, Grass and Nelson. Many smaller streams and creeks carrying waters from fens and bogs drain into the lakes and rivers.

## **1.4 Regional Geology**

The regional geology is described as follows:

The Thompson Mine is in the Thompson Belt, and is the largest nickel deposit associated with ultramafic rocks in the Canadian Shield. The deposit is situated on the boundary between the Churchill and Superior Provinces in northern Manitoba. The Thompson Nickel Belt trends in a north-easterly direction and is considered to be generally fault bounded on both sides. To the northwest, it is in contact with predominantly Churchill Province Kisseynew para-gneisses of greywacke composition. To the southeast, the Belt is in contact with the Pikwitonei Region of the Superior Province. The region consists of acidic and basic granulite facies containing granulite facies gabbros and later gabbroic to ultramafic intrusions of Molsen Age.

The Thompson Belt comprises acidic to basic gneisses with numerous bands of metasedimentary and metasedimentary-metavolcanic assemblages with acidic, basic and ultrabasic intrusions. The gneisses consist of amphibolitic gneisses, as well as quartzofeldspathic, paragneisses and orthogneisses which have a variable mafic component. All members of the gneissic suite are variably migmatized. The acidic intrusions are of two ages, older orthogneisses and younger intrusions of Hudsonian Age.

## **1.5 Description of Vale Canada Limited – Manitoba Operations**

Thompson Mine Ore Body was originally discovered in 1956 by the International Nickel Company of Canada (Inco). In the subsequent years, the T-1 head frame was constructed along with a mill, smelter and refinery process. 1961 saw the first 99.9% pure electrolytic nickel produced. The operation continued to grow and develop with mining operations at

Moak Lake (decommissioned)

SOAB North (decommissioned)

SOAB South (decommissioned)

Pipe Mine (Care and Maintenance)

Birchtree (Operational)

T-1 Mine (Operational)

T-3 Mine (Operational)



## Thompson Open Pit

In 2007 Inco was purchased by the Brazilian company “Compania do Vale Rio Doce” which was abbreviated to CVRD and is now known as Vale. Vale continued to invest in Manitoba Operations with a view to improving its infrastructure, environmental footprint and extending the life of mine.

In 2010 Vale Canada Limited (VCL) announced the decommissioning of the Thompson smelter and refinery by 2015. In 2014 a performance agreement was reached with Environment Canada to operate the Smelter and Refinery until 2019 was agreed upon in principle with Environment Canada.

The Vale Manitoba Operations currently has approximately 1500 direct employees.

## Summary

Ownership: Vale Canada Limited (100%)

Location: Manitoba (“Thompson Nickel Belt”), Canada

Products: Refined nickel products & copper concentrate

By products: Copper, cobalt, gold, PGMs

Producing Thompson (T1 and T3) – underground

Mines: Birchtree – underground

R&R: P&P 25.6Mt @ 1.74% nickel grade

M&I 98.1Mt @ 0.68% nickel grade

Inferred 217.1Mt @ 0.5% nickel grade

Infrastructure: 12 kilotons per day ore @ 500 tons / hour concentrator

(Nameplate capacity; “Mill”)

50 kilotons contained nickel per year capacity nickel smelting complex

(“Smelter”)

50 kilotons finished nickel per year capacity electrolytic nickel refinery

(“Refinery”)

Hydroelectric power (MB hydro)

Water

### Thompson Nickel Operations overview

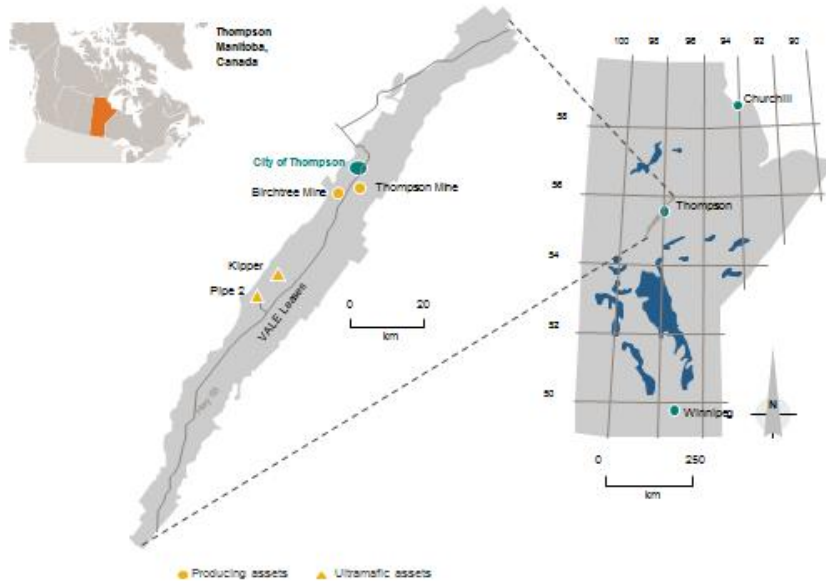

## 1.6 Summary of Process

Vale Canada Limited Manitoba Operations is an integrated Mine-Mill-Smelting-Refining operation which produces on average 100 Million pounds of nickel annually in three primary products:

R – Rounds

S – Rounds

Slab/Plate

The operation has a work force of approximately 1500 direct persons and operates the facility on a 24/7 basis, and 400-500 indirects (contractors).

From a very high level operating perspective the process can be represented pictorially as shown below

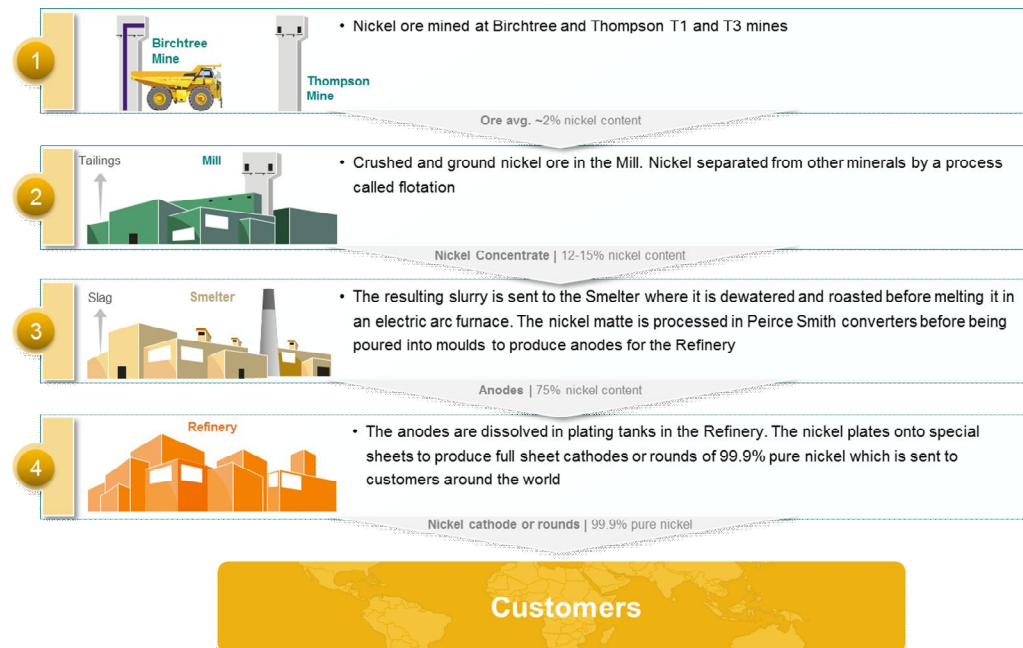

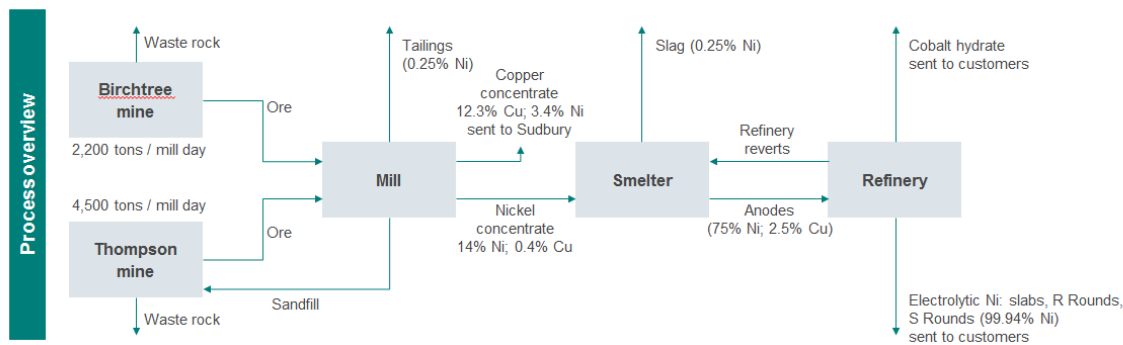

In addition to its over mine feed, Manitoba Operations currently processes nickel concentrate from the Voisey's Bay mine in Labrador. Vale has decided that from 2019 onwards the Manitoba Operations will be changed to a mine-mill facility and a new Concentrate Load-out facility is to be built in Thompson. This is to facilitate the shipment of nickel/copper concentrate from Manitoba Operations to customers around the world

## Mines

Vale Manitoba Operations currently consists of three operating mines (T1, T3 and Birchtree) and one "Care and Maintenance" mine (Pipe Mine). The facility also has an operation at Manasan Quarry where quartz is produced and a Gravel Quarry where sand is produced for use in the Smelter process.

## Mines overview

### Birchtree Mine

- Located 8km (5 mi) south of Thompson
- Utilizes a mixture of bulk mining and mechanized cut-and-fill mining methods in both primary and remnant ore zones
- Produces 2,200 tons per day
- Shaft was developed in 1966 to the 2,750 level. Today, it is 4,200 ft. deep
- To date, almost 21Mtons have been mined for a total of 800 million pounds of nickel
- About 180 employees work at Birchtree mine, providing 24/7 coverage

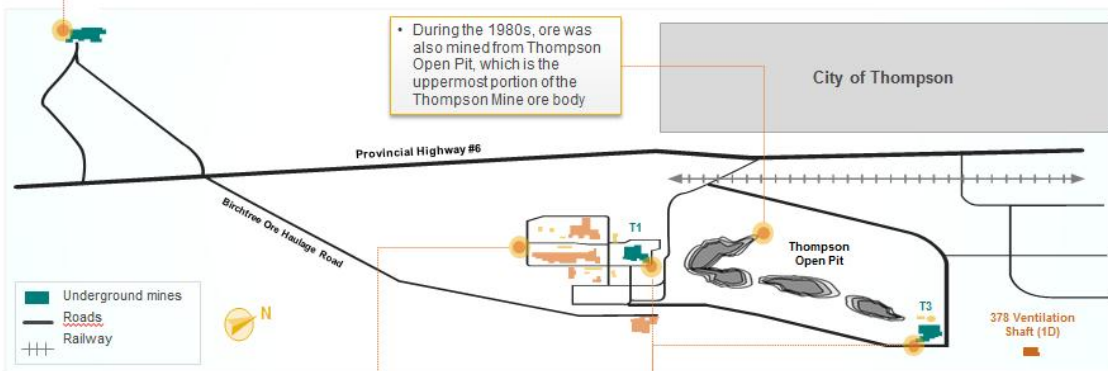

### Thompson Plant Site

- Beneficiation plant (concentrator 50 kilotons per year nickel smelting complex with two 30MVA electric furnaces)
- 50 kilotons per year electrolytic nickel Refinery
- Electric power provided by Manitoba Hydro
- Rail / overseas shipping transportation link
- Tailings disposal / settling pond

### Thompson T1 and T3 Mines

- Located at the site of the original ore discovery in 1956, also utilizes a mixture of bulk mining and mechanized cut and fill
- Ore is produced from two underground areas surrounding the T1 and T3 shafts
- All ore is hoisted to surface via T1 shaft at a rate of about 10,000 tons per day capacity
- T1 and T3 mines currently produce a combined 4,500 tons per day (3,000 tons per day T3; 1,500 tons per day T1). T3 production capacity is limited to 4,000 tons per day by 3,600 level tramming capacity from T3 to T1
- T1, developed in 1957, is 4,200 ft. deep; T3, sunk in the early 1960s, is 2,600 ft. deep
- To date, more than 83Mtons of ore have been mined for a total of 5.6 billion pounds of nickel
- Approximately 535 employees work at Thompson mine providing 24/7 coverage

## **Mining Methods**

### **Mechanized cut and fill mining**

Holes are drilled horizontally into the ore body with jumbo drills. The holes are charged with explosives which, when detonated, cause the ore to break and tumble into the working stope; A load-haul-dump vehicle scoops up the broken ore and hauls it to an ore pass, where it is sent to a crusher. The crusher reduces the ore to roughly six-inch diameter pieces.

### **Vertical (Bulk) Block mining (VBM)**

Holes are drilled down through the block from a top sill with large in-the-hole drills. The holes are charged with explosives which, when detonated, cause the ore to break and fall to the bottom of the block;

A remotely operated load-haul-dump vehicle scoops up the broken ore, and hauls it to an ore pass where it is sent to a crusher, which crushes the ore into roughly six-inch diameter pieces; Each block is approximately 100 ft. from top to bottom and about 50 to 60 ft. in diameter.

The working area is conditioned with rock bolts, screen and sometimes a compound called shotcrete to ensure the area is safe for the jumbo drill operators to move back and repeat the cycle

The following sections will describe the various operations within the operation plus present the current state of the various other properties currently held by Vale.

**Reference: Appendix #1 for Thompson Site Plan and Appendix #2 for Operations flow sheet**

## **Section 2 Operational Sites**



## 2.1 Thompson Open Pit

The open pit mining operations at Thompson Mine commenced in the Spring of 1981 with the approval of a 104 m (340 ft.) deep open pit to recover the crown pillar between the T-1 and T-3 shafts. A small lake and about 30 m (100 ft.) of overburden were used to cover the pit area. About 25 million cubic meters (33 million cubic yards) of overburden was dredged in the two pit development campaigns between 1981 and 1990. A total of four pits were excavated over a period of approximately 10 years. 1A Pit (73 m deep (240 ft.)), 1B Pit (104 m deep (340 ft.)), and 1C Pit (85 m deep (280 ft.)) are elongated pits trending north-south parallel with the orebody. The 2-Zone Pit is a 107 m (350 ft.) deep open pit and is oriented northwest-southeast and located west of the 1A Pit. The 2-Zone and the 1B pits were mined down to the top of the underground workings. Crown pillars were left in the 1A and 1C pits. The location of these open pits in relation to the other mine facilities is shown on Thompson Mine Site Plan.

The open pits were excavated using conventional drill and blast techniques with 2 – 6 cubic meter (8 cubic yard) electric shovels and 11 - 59 to 77 tonne (65 ton to 85 ton) haul trucks. Ore was hauled to the plant site crusher while waste was used to construct several surface facilities as well as placed in designated dump areas. In total, approximately 7.9 million tonnes (8.7 Mt) of ore and 20.3 million tonnes (22.5 Mt) of waste rock were excavated from the four pits.

### Current Conditions and Future Development Plans

All four open pits within the Thompson Mine site are currently in active. There are plans to remove ore from the 1A crown and the 1B ore zone rib pillars before the end of Thompson Mine life. In order to provide rockfill for the Birchtree Mine, Vale currently quarries the rock shoulder to the west of the south end of the 1C pit.

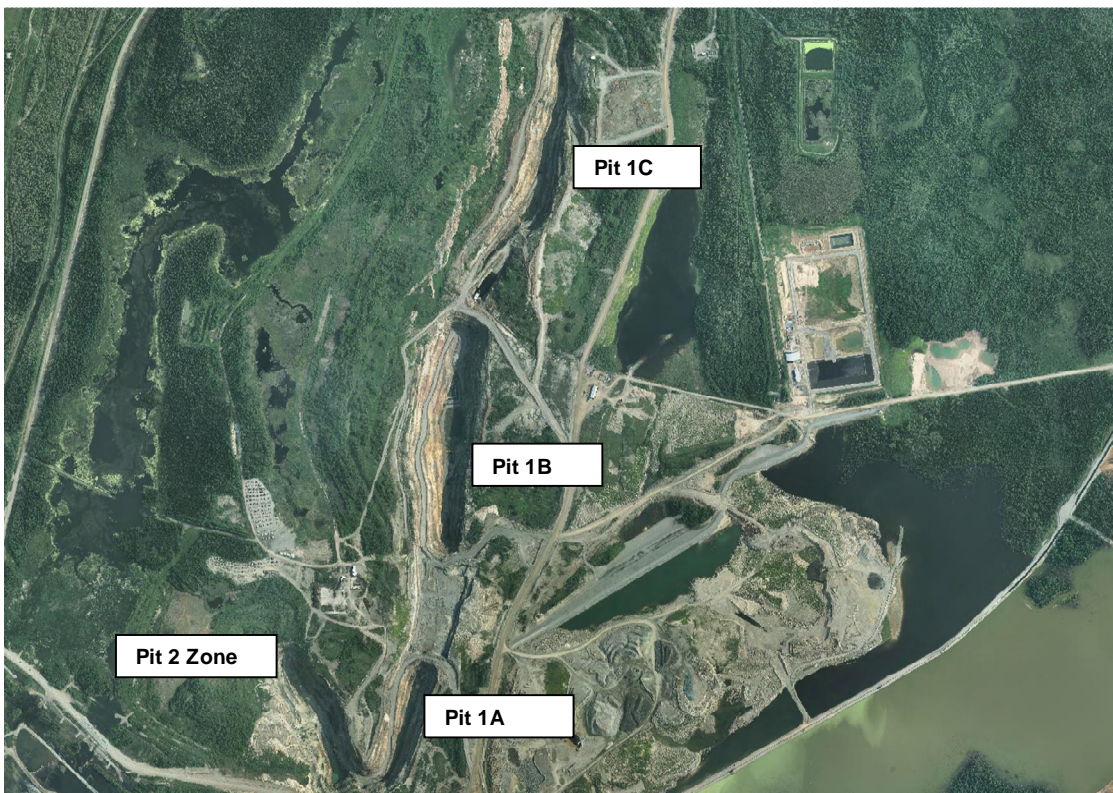

## 2.2 Manasan Quarry

Quarrying activity first started at the Manasan quarry site in the early 1960's. The quarry has been intermittently used by both Manitoba Hydro and by Vale (Inco) as a source of quarried rock, primarily quartz. The quarried material is used by Vale (Inco) as a flux in the Thompson smelter.

The Manasan Quarry is located approximately 6 km (3.8 mi) south of the Thompson Mine on Provincial Hwy 391. Currently the Manasan Quarry has a maximum depth of 38 m (125 ft.). It is an elongated "L shaped" pit which trends from north to south and from northeast to southwest to follow the quartz rock vein.





### 2.3 Gravel Quarry

VCL - Manitoba Operations has the quarry rights to a sand and gravel deposit approximately 5 kilometers north of the City of Thompson (near the airport). The deposit is quarried to produce sand which is hauled by a local contractor for use in the Smelter process.



## **2.4 Birchtree Mine**

Birchtree Mine is located 8km (5 mi) south of Thompson. It is self-contained operation with its own raw water pumping station, water treatment facility, effluent plant and waste water treatment facility. The mine utilises a mixture of bulk mining and mechanised cut-and-fill mining methods in both primary and remnant ore zones. Initially developed in 1966 to a depth of 2,750 feet, today the Birchtree Mine Drift is 4,200 feet deep. The mine produces approximately 2,000 tons per day of ore which is transported via truck to the Mill or placed on stock pile at the T-1 facility utilizing a separate Birchtree-Thompson Plant Ore Haulage Road. Backfill operations in the mine use waste rock back-hauled in Ore Haulage Trucks from the Thompson Plant as well as utilizing development waste created as a result of mining operations at the mine. The rock used for fill is consolidated with cement delivered by an onsite system. Future mining operations will continue to use these waste by-products as a source of backfill at the mine. Approximately 180 employees work at Birchtree mine, providing 24/7 coverage.

Explosives are delivered to the headframe on a regular basis and moved underground to the designated explosive magazines using strict guidelines for the transportation of explosives. From these magazines the explosives are distributed to the working areas for blasting purposes. Blasting occurs twice daily at 6am and 6pm (approximately) with blasting being initiated remotely.

A brief timeline of improvements at the mine at Birchtree is as follows:

1966 Commercial production

1974 Deepening project starts

1978 Birchtree put under Care and Maintenance

1989 Birchtree reopened

1997 Shaft deepening project completed to 4,083 feet

2002 Initial production from the 84 Ore Body

2004 Thyristor Drive Skip Motor Upgrade

2006/2007 Upgrade of existing Waste Water Treatment facility

2008/2010 Upgrade of Raw water delivery to the Mine (pumps, piping distribution)

### **Potable Water**

Raw water is pumped to Birchtree Mine from the Burntwood River via a 10" buried line. A small water treatment plant exists at the Mine to produce Potable water. The waste water from the potable water treatment plant is directed to the Birchtree effluent plant (as part of the mine waste water) for treatment before discharge to the Burntwood River.

### **Birchtree Waste Management and Treatment Systems**

#### **Landfill Site**

In 1992 the Birchtree Mine scrap steel and timber dump was closed and decommissioned. A total of 200 tons of steel and 50 tons of timber were removed. The scrap steel was delivered to

a storage area and sorted for recycling. The timber was buried in the borrow pit excavated for the clay used for covering the dump. A small area containing 200 tons of waste rock was sampled and identified to have acid generating potential. Calculations were made to determine the amount of basic material required to neutralize the acid producing potential. The area in question was covered with ten tons of minus ¼-inch limestone. A one metre layer of clay (3,825 cubic metres) was placed over the entire dump area of 4,830 square metres. This was completed by mid-December 1992. The area was seeded in June 1993 and is now covered/rehabilitated.

All other waste materials and garbage is hauled for disposal or recycling at designated disposal areas located at the main Thompson Processing Plant site on a regular schedule during the mines operation.

## **Sewage**

The Birchtree Mine operation pumps its sewage from the mine to a double-cell sewage lagoon located approximately 1 kilometre east of the mine site just off the ore haulage road. Sewage lagoon operations and maintenance adhere to the recommendations outlined in the "Recommended Operation and Maintenance of Sewage Lagoons Manual" distributed by the Manitoba Government, Environmental Control Services. The treated sewage effluent is discharged, on average, 3 times per year. The treated effluent is discharged into the wetlands north-east of the lagoon which drain into the same system into which the city of Thompson's sewage treatment lagoons are discharged.

Underground, portable toilet facilities are available for use by personnel. As part of the normal operation of the mine, these units are drained/pumped into a specific tanks and hoisted to surface for disposal into the Birchtree sewage lagoon.

## **Mine Wastewater**

Mine wastewater, excluding sewage water, comes from 2 sources at the mine site:

Surface yard drainage water and  
underground mine process and drainage water.

Underground drainage and process water is pumped from underground settling sumps to a series of two settling ponds and collects in a third holding pond, where it is combined with mine surface drainage water. Effluent from the holding pond is pumped into the effluent plant where it is treated before being discharged. Treated effluent is discharged into Manasan Creek which flows into the Manasan and Burntwood River system. The mine draws water on demand from the river pumphouse to use as process water.

Surface runoff is collected in the effluent plant holding pond. Cement from underground back fill operations and most of the accumulated sediments have settled out before the effluent enters the holding pond. The holding pond is connected to a well, situated below the effluent plant. The

water is gravity fed to the well and then pumped through two sand filters to trap any remaining sediment before entering the ion exchange columns. Water enters the top of the first ion exchange column and filters down through the ion exchange resin beads. The resin beads adsorb the metals from the water through an ion exchange process. Water exits the bottom of the column and proceeds to a second column. This column will extract the remaining metals in the same fashion as the previous column.

Treated water has nickel concentrations of less than 0.5 ppm and is discharged into Manasan Creek. Over a period of time, the "lead" column will become saturated with metals and the column will be regenerated. During this procedure, the metals are stripped from the beads. The beads are replenished and are able to continue extracting dissolved metals. The regeneration process strips the nickel from the beads using two different acid solutions. A diluted hydrochloric acid solution is recirculated through the column first to remove the maximum amount of calcium and a minimum amount of nickel from the beads. This solution is pumped to a tank for temporary storage. A dilute sulphuric acid solution is then recirculated through the column. This solution strips all the nickel and remaining metals from the beads. The nickel concentrate solution created during the stripping process is pumped to an eluate tank where it is then transferred to a tanker truck and transported to the refinery copper ponds. The Birchtree Effluent Treatment plant can treat effluent at a rate of 400 gal. /min

### Birchtree Input/output Block Diagram

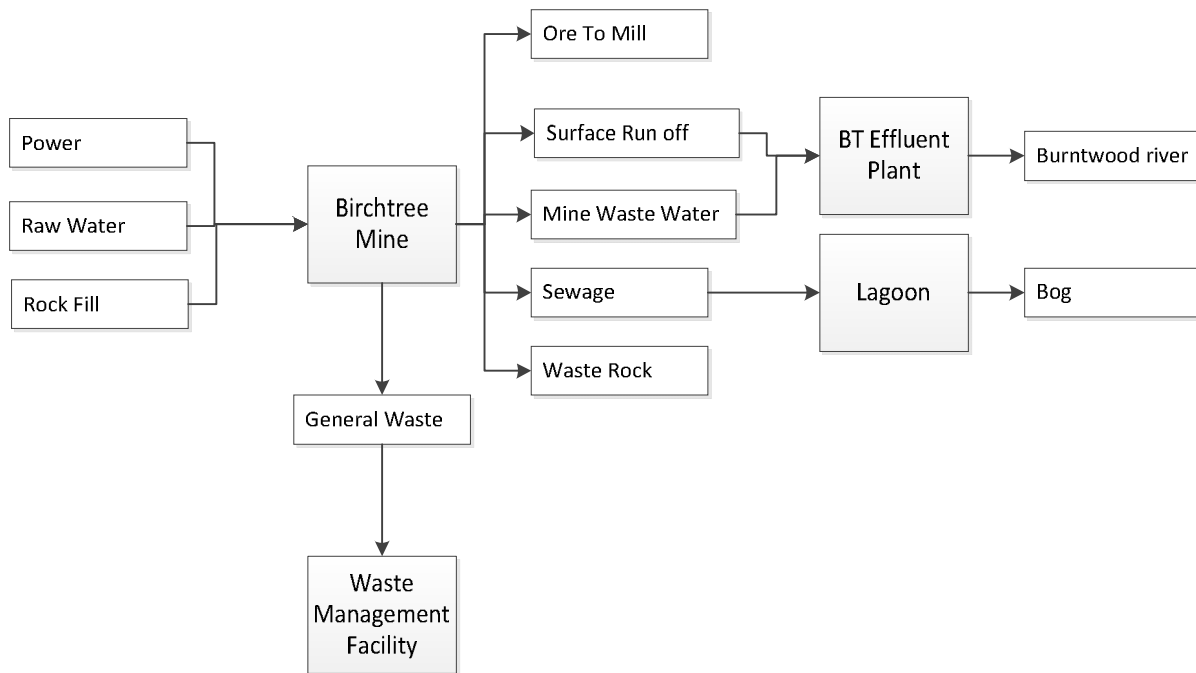



Effluent Treatment Plant

Haulage Road

BT Headframe

Waste Rock



## **2.5 Thompson Mine**

Thompson Mine is located on the Vale Manitoba Operations property adjacent to the City of Thompson. Vale Canada Ltd. is the sole owner of the mining property and all associated nearby surface and underground mineral rights in the Thompson Nickel Belt (TNB).

Thompson Mine is located at Latitude 55° 45' 0" North, and Longitude 97° 52' 0" West in the Thompson Nickel Belt in northern Manitoba as shown. It is part of an integrated facility that includes a Mill, Smelter, and Refinery as well as support service offices. The mine utilizes a mixture of bulk mining, room and pillar / cut and fill, and specialized mining methods in both primary and remnant ore zones. Mining at T-1 began in 1959. The T-1 five compartment shaft developed to a depth of 2,247 feet in 1958, is now 4,427 feet deep. T-1 mine produces approximately 1,600 tons per day of ore which is combined with 3,300 tons per day of T-3 ore and skipped directly to the Mill or placed on the stock pile located at the main surface plant area.

The former Inco began exploring for nickel in Northern Manitoba in 1946 - partly as a result of the Sherritt Gordon Mines discovery at Lynn Lake. From 1948 to 1954, several airborne geophysical surveys were conducted. In 1955, detailed ground magnetic and electromagnetic surveys were completed in the vicinity of Thompson Lake. The ground conductor indicated the presence of a fold that was believed to be a favourable environment.

In early 1956, drilling tested the Thompson Lake geophysical anomaly. The first attempt was abandoned due to problems with the overburden. The second hole (drilled from the same location) encountered 19.7 feet of sulphide grading 2.69% nickel (Ni). Two subsequent holes, drilled to test the same anomaly, also intersected nickel-bearing sulphide. Further drilling confirmed the presence of a large nickel-rich orebody. Later that year, Inco announced its decision to proceed with the construction of a fully integrated mine-mill-smelter-refinery complex.



Significant historical events for Thompson Mine

- 1948 – Airborne aeromagnetic surveys within the region.
- 1954 – Thompson Mine area staked.
- 1956 – Diamond drilling results indicate significant nickel ore body.
- 1957 – T-1 and T-2 Shafts are collared over 1-A and 1-B orebodies, respectively.
- 1959 – T-1 Shaft (main production shaft) driven to a depth of 2,106 feet,  
T-2 Shaft (ventilation & services raise) driven to a depth of 1,057 feet.
- 1961 – First 99.9% pure nickel plate produced in the refinery.
- 1965 – T-3 Shaft (cage & services shaft) is collared over the 1-C orebody.
- 1967 – T-3 Shaft driven to a depth of 2,607 feet.  
T-1 Production Shaft deepened to 4,423 feet.
- 1970s – Employment peaked at 4,400 employees.
- 1984 – Mining began in the Thompson Open Pit (TOP)
- 1993 – Suspended mining in the TOP, after producing 458 million pounds of nickel.  
378 Shaft (ventilation & services) collared over the 1-D orebody.
- 1994 – 378 Shaft driven to a depth of 3,565 feet.
- 1995 – Bulk production from the 1-D orebody between 2400 – 3500 levels begins.
- 2000 – Milestone: produced 4 billion pounds of nickel.
- 2004 – Cut & Fill mining of the 1-D Lower between 3800 – 4160 levels begins.

2007 – International Nickel Company of Canada (INCO) purchased by Brazilian Compañia do Vale Rio Doce (“Sweet River Valley Company”)

2010 – Milestone: produced 5 billion pounds of nickel.

2012 – Bulk Mining of the 1-D Footwall Deep, below 4200 Level begins.

Both T1 and T3 are 24/7 operations and have a total of approximately 535 employees. Both T1 and T3 utilize a mixture of bulk mining and mechanized cut and fill mining practices. The ore mined at T3 is railed underground at the 3600 foot level to T1 ore pass system. There are two ore pass systems one for T1 and one for T3. The ore in these systems is then crushed and hoisted via the T1 shaft to the Mill or stockpile. The typical hoist rate is 6,000 tons a day, though the system capacity for 10,000 tons per day.

Rockfill at T1 and T3 is produced on the various levels and stored in non-active areas for use in the backfill purposes. Excess rock at T1 is hoisted to surface and placed on the waste rock pile. In addition sandfill (produced in the Mill) is distributed from surface to the two mines. The sandfill is mixed with the waste rock and is used to fill the voids created by the mining practices.

Explosives are delivered to the headframes on a regular basis and moved underground to the designated explosive magazines using strict guidelines for the transportation of explosives. From these magazines the explosives are distributed to the working areas for blasting purposes. Blasting occurs twice daily at 6am and 6pm (approximately). Blasting is initiated remotely in both areas.

For the T-3 Mine, due to an aging hydraulic sandfill system and the high costs associated with using crushed aggregate in our rockfill system, paste backfill has been chosen as the proposed system for filling the mined-out production blocks in T3 Mine’s Footwall Deep ore-body. Cemented paste backfill contains a higher percentage of solids compared to hydraulic backfill and therefore produces a more competent backfill product. Less total binder is required to produce similar compressive strengths, resulting in lower operating costs and a cleaner and more efficient backfilling system.

Unlike the current hydraulic sandfill system, which can only use the coarse tailings material as backfill (32% of the AS4 tailings stream), paste backfill allows the coarse and the fine materials to be used in the backfilling process (80% of the AS4 tailings stream can be used for producing backfill).

The proposed paste backfill system will produce a more cost effective backfill and will also allow a greater percentage of the total tailings stream to be sent back underground, rather than being sent to the surface tailings ponds. The paste fill system is currently in Feasibility Study Stage (FEL 3) and has not yet been approved for execution.



## **Mine Inputs and Outputs**

### **Water: Process and Potable**

The Utilities building provides the plant site buildings with potable (drinkable) water via an 8" line. At T-1 this line runs down the shaft and splits to a 4" water line that continues down the shaft to supply T1 mining operations, and a 6" water line that runs across to T-3 Mine where it provides for mining operations and the T-3 headframe building. T-1 Mine is currently undergoing a change to provide process water to mining operations by tapping into the Mill's 12" process water line and connecting it to the 4" T-1 Water line in the shaft while maintaining potable water to T-3 Mine. A future project will look at providing process water to T-3 mining operations while maintaining potable water for the T-3 Mine office staff.

### **Mine Wastewater**

Mine wastewater comes from three sources at the mine site: plant runoff (rain), the Thompson Open Pit (rain, groundwater), and underground (mine process water, groundwater). Underground process water and groundwater is collected in settling sumps and is pumped to surface and ultimately to the tailings ponds. Thompson Open Pit water is pumped either to a lagoon for temporary storage, or directly to the TMA. Plant runoff is collected in sewer catch basins located throughout the plant site and directed to tailings via the sewer lines.

### **Sewage**

Sewage from the main plant site including T-1 mine site (all areas) enters the 48" and 42" sewer for discharge into Area 1 of the Tailings Management Area (TMA). Weir type structures within the TMA holds the contaminant (mixed with tailings) and assists in depositing the solids within the TMA. This essentially makes the TMA a multistage lagoon and is aligned with the approved license for the facility. Testing at the discharge of the Weir for coliforms and other pathogens has yielded negative results.

Underground, portable toilet facilities are available for use by personnel. As part of the normal operation of the mine, these units are drained/pumped into a specific tanks and hoisted to surface and hauled in the case of T1 to the Thompson Sewage Treatment Facility while T3 is deposited into the T3 sewage lagoon for disposal.

### **Waste Material**

Manitoba Operations has adopted "SLAM Dunk," a nine stream colour-coded waste bin system to segregate waste based on material. These range from office paper, general recyclables to industrial materials such as scrap metals, plastics, and rubber, with only one

stream for garbage. Additionally, unique waste materials such as asbestos, concrete, and waste oil are handled by the Waste Material Facility.

### Non-Nickel Bearing Rock

Rock created from driving development underground is either placed into recently mined out stopes along with sand-sized mill tailings that may include cement, or hoisted to surface and used in tailings pond construction. Cemented sandfill with development rock distributed similar to a parfait is required to maximize ore recovery when mining the adjacent stopes.

### T1 & T3 Input/output Block Diagram

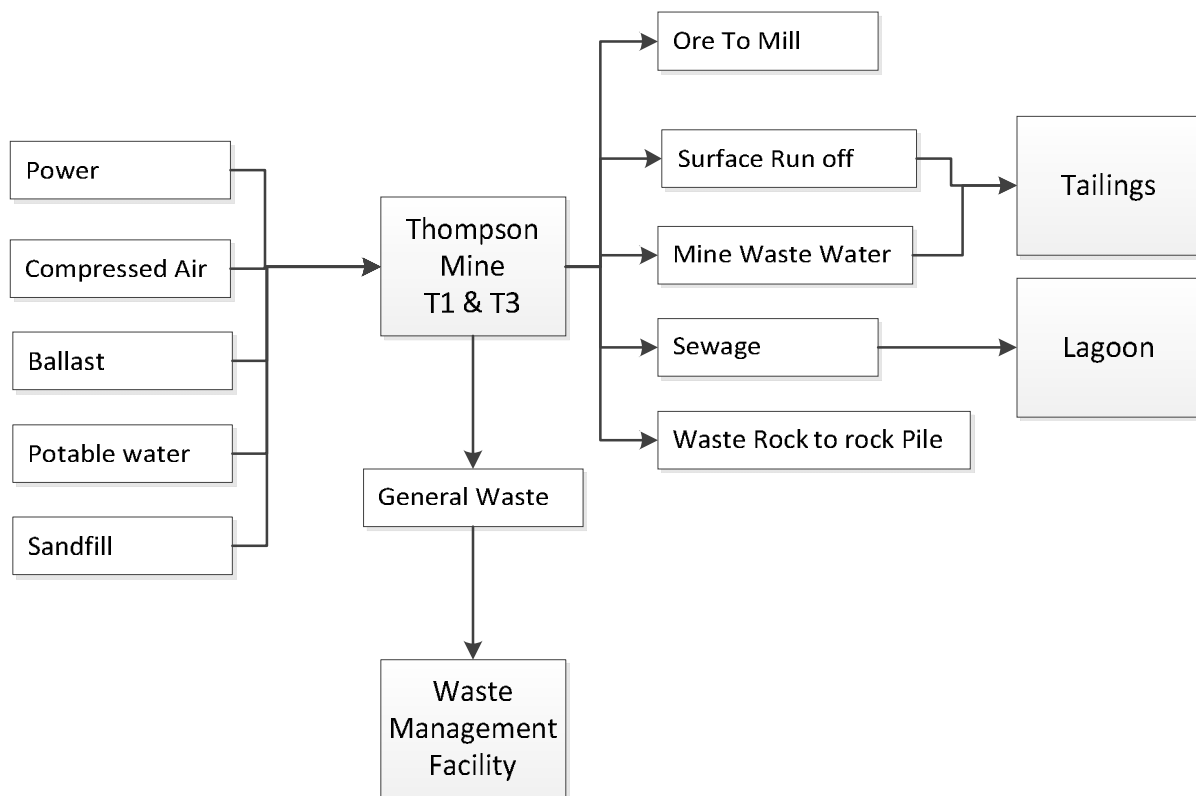

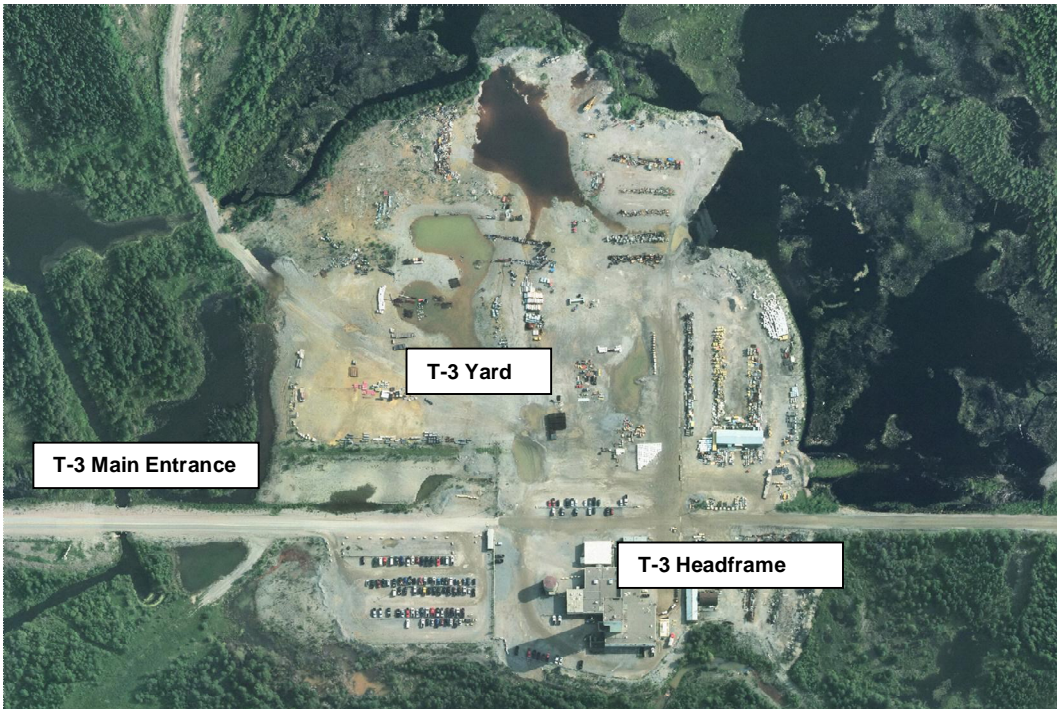

## 2.6 Mill

The Mill, with a workforce of about 70 employees, has the capacity to process approximately 12,000 tons of ore daily. The purpose of the Thompson Mill (Concentrator) is to separate, collect, and then concentrate the nickel (pentlandite) and copper (chalcopyrite) minerals from the barren rock (gangue). The Mill typically processes 8,000-10,000 tons of run-of-mine (ROM) ore per day, five days a week. The Mill receives ore from Birchtree and stockpiles via rock truck but the ore from Thompson Mines is directly hoisted into the Mill. Most ore comes into the mill at a size of six inches or less and can assay anywhere between 1.2% to 2.5% nickel and 0.1% copper when combined. Once ore enters the Mill, it is first crushed to less than (<) 1/2" by large cone crushers and then wet ground to the size of sand by rod and ball mills in the grinding area. This stage is known as comminution or liberation (i.e. crushing and grinding) and is used to break the ore and separate the valuable pentlandite and chalcopyrite minerals from the non-valuable gangue minerals. Minerals must be liberated from one another for a successful separation to occur. The final product from the comminution stage is ground slurry (40% solids at < 105 microns) which is then pumped to a multi-stage froth flotation circuit where chemical reagents and air is introduced. This enables the valuable minerals to be collected (making a concentrate) and the non-valuable minerals to be removed as a tailings product.

The final Mill products are a nickel concentrate averaging 13% to 14% nickel (Ni) and 0.4% copper (Cu), a copper concentrate averaging 13% Cu and 4% Ni, sand fill for the Mines, and tailings waste that averages 0.2% Ni and 0.02% Cu. The Mill is ultimately able to recover anywhere from 85% to 90% of the valuable minerals from the ROM ore that is received. On a typical production day the Mill will process 9,000 tons of ore making 950 tons of nickel concentrate, 50 tons of copper concentrate, 1600 tons of sandfill and 6400 tons of tailings. Currently, nickel is sent in slurry form to the Smelter. Copper concentrate is shipped to the Company's Ontario operations for processing

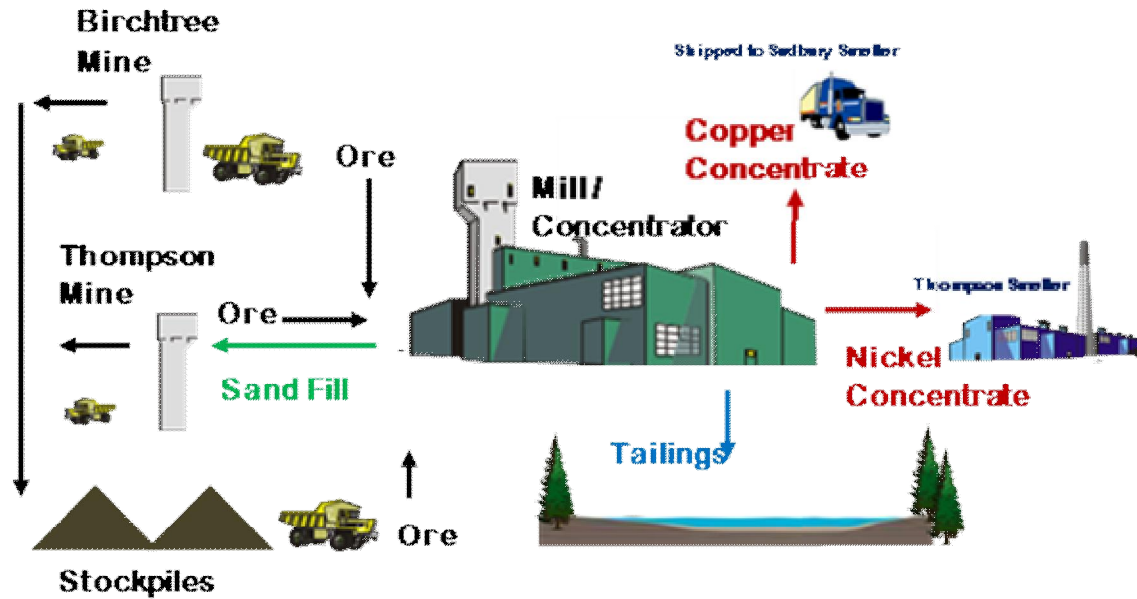

## Plant Design

Thompson (TH) and Birchtree (BT) ores are blended and processed together in the Thompson Mill. First, the ROM ore is delivered to the mill via hoist or the outside conveyor system to one of the two coarse ore bins (COB). Ore that is directly hoisted into the Mill reports to the “Thompson Bin” and ore brought in via the outside conveyor system reports to the “Moak Bin”.

From the COB’s, the ore is crushed in two stages through an open circuit crushing loop. This means that a particle of ore goes through the crusher system only once. The plant layout has three separate crushing legs each with a Deister screen, 7’ standard cone crusher, rod deck screen, and a 7’ shorthead cone crusher. The crushed ore is then conveyed to one of three fine ore bins (FOB) where it stays until it enters the grinding circuit.

The grinding aisle is equipped with a total of nine grinding mills (six ball mills and three rod mills) which enable a large variety of throughput options that include, but are not limited to, production rates of 300 tons/hour, 400 tons/hour, and 500 tons/hour. All of the mills are 12 ½ feet x 16 feet, Dominion Engineering mills powered by 1,500 horsepower motors turning at 225 rotations per minute (RPM).

From the fine ore bins, the ore is conveyed to a rod mill where it is ground in open circuit. Then, it moves on to the ball mills which are operated in closed circuit by the use of hydrocyclones or cyclopacs depending on the operating configuration needed to meet production targets.



After crushing and grinding, flotation of the cyclone overflow is carried out in the rougher flotation stage after prior treatment with reagents. Rougher tailings are reground and subjected to scavenger flotation. Rougher concentrate is cleaned and the tailings from this step of the process are combined with the scavenger concentrate to feed the scavenger cleaners. The scavenger tailings and scavenger cleaner tailings make the final mill tailings. Rougher cleaner concentrate is subjected to copper/nickel separation to ultimately make two separate concentrates.

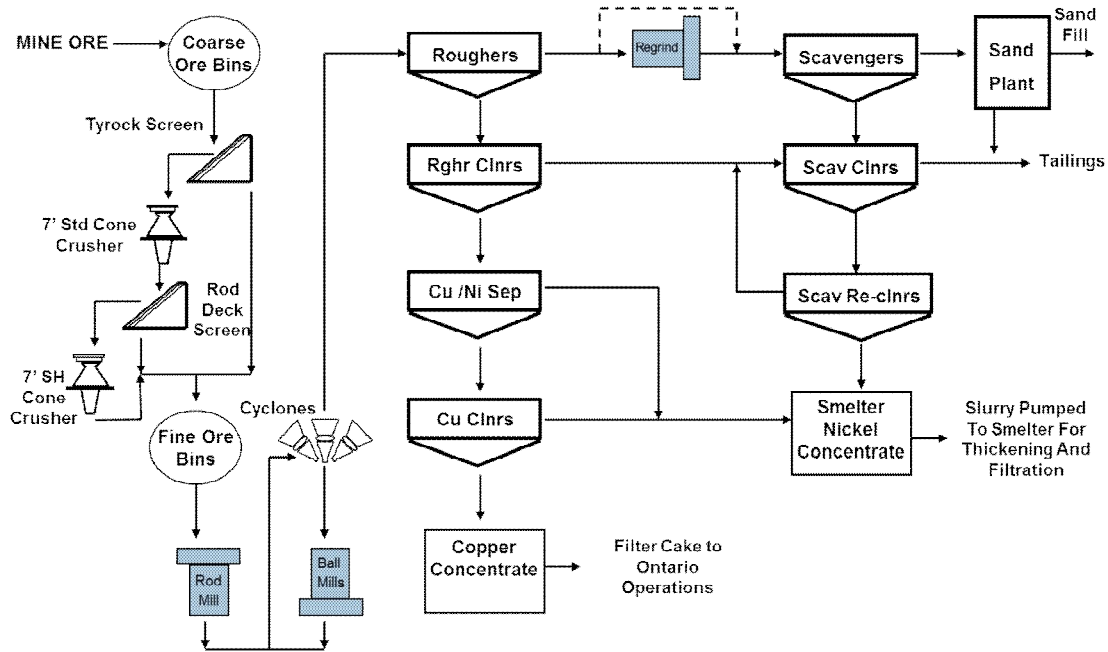

## Crushing

The purpose of the crushing plant is to take run-of-mine ore from approximately six inches in size and reduce it down to a target size of 30% to 40% + 1/2". This means that once the ore has passed through the crushing plant, approximately 35 % of the particles are greater than 1/2" in diameter.

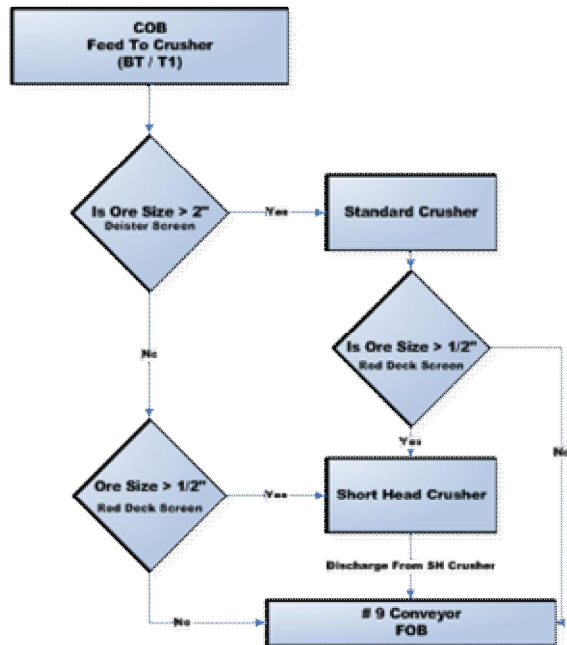

Figure 10: Crushing Process Map

## Crushing Circuit Operation

The Thompson Mill has what is called an open-circuit crushing loop which means that a particle of ore goes through the crusher system only once. The layout has three separate crushing legs, each with a Deister screen, a standard crusher, rod deck screen, and a shorthread crusher. Due to elevated noise and dust when crushing ore, the crushing area requires the use of double hearing protection and is considered a mandatory respirator area. Ear plugs, muffs, and respirators must be worn at all times when the plant is running.

Ore enters the crushing plant from the coarse ore bins by the coarse ore feeders and the wood picking conveyors. Between the wood-picking belts and the Deister screens are electro-magnets which are used to remove steel debris from the ore stream. They are suspended on an electric monorail and must be positioned just above the opening in the top of the transfer chute connecting the wood-picking belt to the Deister screens. Ideally, these magnets should be as close to the ore as possible so as to enable them to pick up as much tramp steel as possible. The double deck Deister screens are 6' x 14' with a 2" x 2" opening on the top deck, followed by fine cloth with ½" zigzag pattern openings.

Once the ore has passed through the Deister screens, it reports to the standard crushers. The Mill's standard crushers are Nordberg 7' Symons Standard Cone Crushers with a closed side setting of 10" – 11 ½" and an open side setting of 11"– 12 ¾". The output size (slug) setting ranges between 1" to 1 ¼" (25-31.25mm). Symons Standard crushers are used for primary crushing.

After the standard crushers, the ore passes over a second set of vibrating screens, known as rod deck screens, before passing to the shorthead crushers. The purpose of the rod deck screens is to remove any new fine particles created by the standard crushers. The rod deck is 5' x 8' with double deck screens openings of 60mm x 18mm in a zigzag pattern. Open area on screen is 41.9%.

Once through the rod deck screens, the ore enters the shorthead crushers. The Mill's shorthead crushers are Nordberg 7' Symons Short Head Crushers with a closed side setting of 2" – 3.8" and an open side setting of 3 3/4" – 5 3/4". The output size (slug) setting ranges between 1/4" to 3/8" (6.25 – 9.38mm). Symons Shorthead crushers are used for secondary crushing.

After passing through the shorthead crushers, the ore recombines with the material removed by both sets of screens and is conveyed from the crushers to the fine ore bins. Baghouses are located throughout the crushing plant for dust control. The Crushing Plant is designed to operate at 400 tons per hour per crushing leg with 20% idle time. All crushers are adjusted with hydraulics to maintain set points and targets.

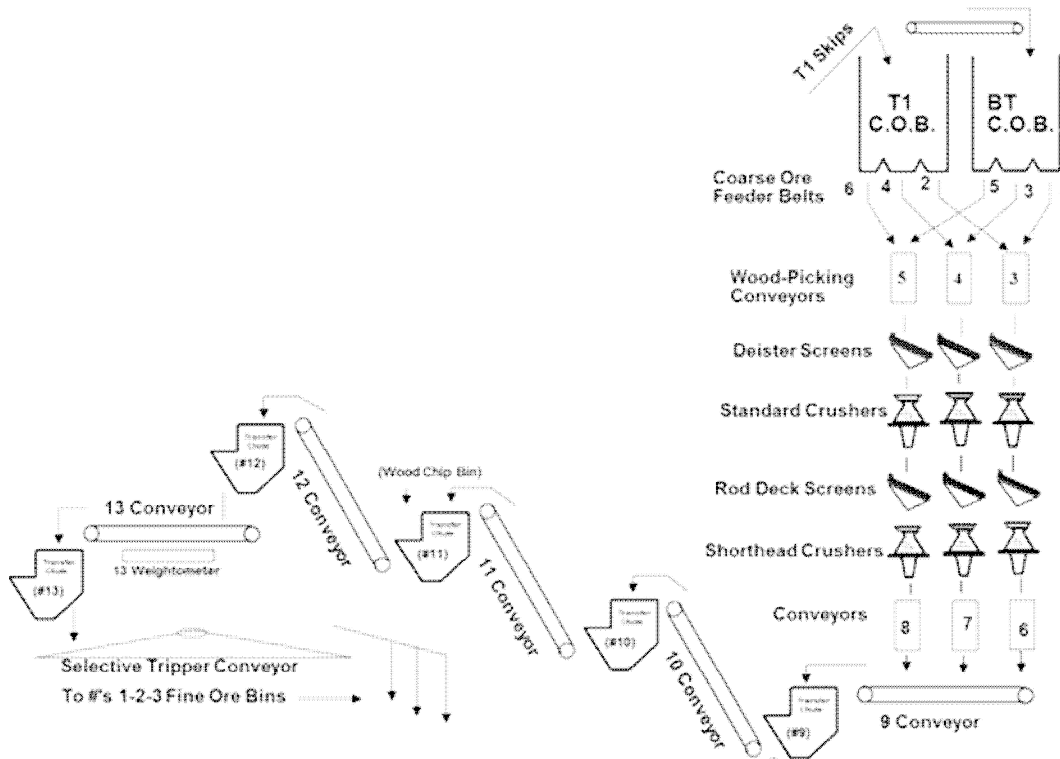

Figure: Crushing Circuit Flow Sheet



## **Production and Quality Measurements**

#13 Conveyor Belt Weightometer is used to measure and account for the tons of crushed ore processed each day. Daily ore sampling off of the #9 conveyor measures the crushing circuit product particle size distribution. This information is used to determine if the crushers and screens are operating correctly.

## **Grinding**

Most minerals are finely distributed within rock and waste material. As a result, they need to be freed from the rock and waste material before separation can begin in the flotation circuit. We grind the crushed ore in order to effectively recover nickel and copper in the flotation circuit. The purpose of the grinding circuit is to further reduce the particle size of the ore and prepare it for the flotation circuit.

The grinding process in the Thompson Mill consists of two main sections: primary rod mill grinding and secondary ball mill grinding. All grinding mill slurry (ore and water) discharges are fed to head tanks connected to hydrocyclones. The hydrocyclones separate freed minerals and waste particles (overflow) from the coarse locked particles that require additional grinding (underflow). The cyclone overflow product reports to flotation circuit and the underflow circulates back to the ball mills.

## **Grinding Circuit Operation**

The Thompson Mill grinding aisle has a large variety of processing options. Production rates include, but are not limited to, 300 tons per hour (tph), 400tph, or 500tph, depending on the milling equipment selected for operation. Some fine ore conveyors can be operated in reverse and send ore from the west or center fine ore bins to the east grinding circuit.

All of the rod and ball mills are 12 ½' x 16' Dominion Engineering mills powered by 1,500 horsepower (hp) motors turning at 225 rpm. The drive trains of all the mills carry a 26-tooth pinion and each mill rotates at 16 rpm, which is 73% of critical speed.

Secondary grinding has a classification stage which includes vertical and inclined cyclones located on both the east and west side of the plant. The discharge from both rod and ball mills goes into a common discharge sump which contains a fixed speed pump. Slurry is then pumped to either the east or west head tanks located at the highest level of the plant. The head tanks distribute the feed between five hydrocyclones located on the east and sixteen hydrocyclones (two cyclopacs with eight 20" cyclones each) on the west. The cyclone overflow product reports to flotation and the underflow circulates back to the ball mills.

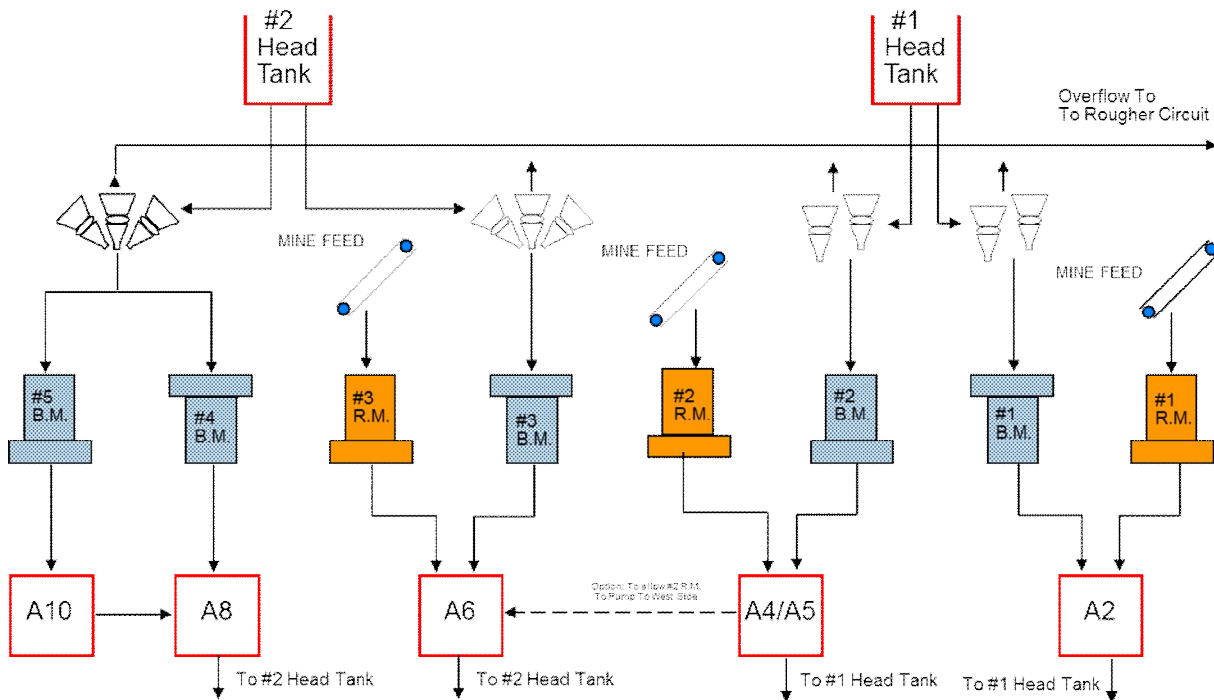

Figure: Grinding Circuit Flow Sheet

## Production and Quality Measurements

Concentrator Recovery and Grade are strongly determined by effective mineral liberation. Primary grinding targets exist to ensure suitable flotation feed to maximize recovery and grade. The final grinding product/flotation feed specifications are:

- Particle Size = 22% + 150 micron (100 Mesh)
- Slurry Solids = 45% Solids

The grinding product is the flotation feed. The stream is called A1A (east) or A1B (west) depending on the grinding side in operation. The grinding product is continuously sampled and measured using metallurgical sampling equipment located in the flotation area. This A1A or A1B sample is analyzed for %solids, particle size, and elemental content including, but not limited to, nickel and copper. Production from grinding is measured from the rod mill feed conveyor belt weightometers.

## Flotation

Mill feed, concentrates and tailings streams are continuously sampled and measured using metallurgical sampling equipment located throughout the Flotation area. These samples are then prepared and analyzed in the laboratory for elemental content including, but not limited to, nickel and copper.

The purpose of the flotation circuit is to separate the nickel and copper-bearing minerals from the rock. The flotation circuit consists of a series of flotation cells which are large, agitated vessels in which air is added. The air causes bubbles to form and bubble formation is aided with the use of a frother. Due to the reagents present in the slurry, the nickel and copper-bearing particles attach to the bubbles, float to the surface, and form froth that overflows from the top of the flotation cell.

Target metallurgy is balanced between the customer requirements and Mill recovery expectations. The Smelter will request between 13% and 14% nickel concentrate depending on the amount of external reverts they need to consume. To meet the customers' needs and still maximize nickel recovery for the business, each individual flotation stream must also have individual targets.

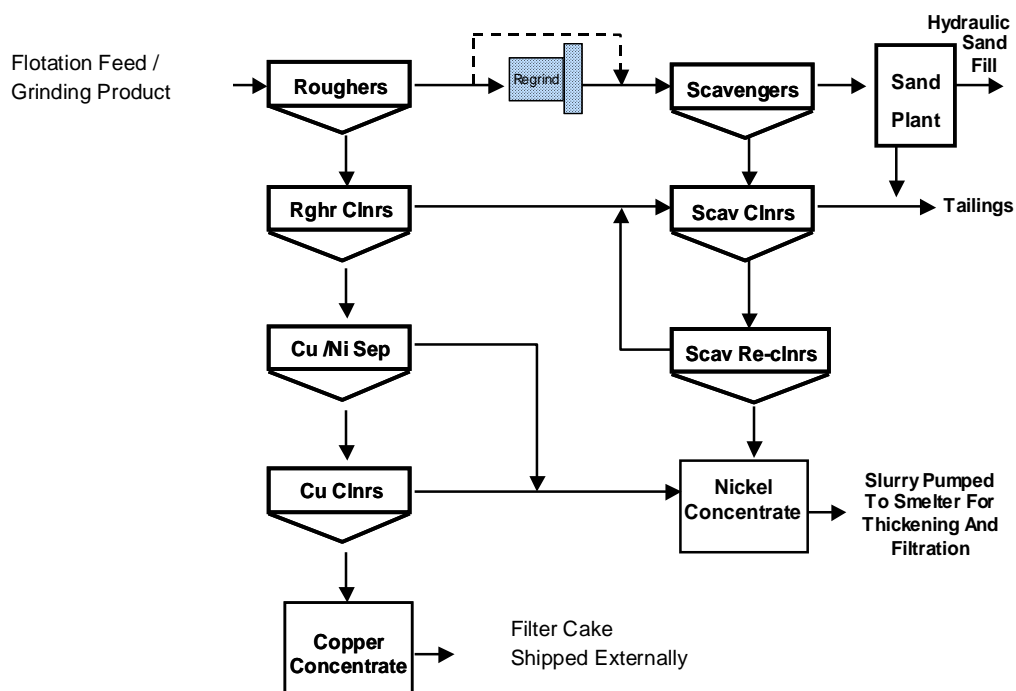

Figure: Flotation Circuit Flow Sheet

Below are the target specifications for the individual flotation streams to produce a final concentrate of 13% and 14% Nickel:

| Stream                           | Tons   | Ni (%) | Cu (%) |
|----------------------------------|--------|--------|--------|
| Run of Mine Ore                  | 10,000 | 1.7    | 0.2    |
| <i>Thompson Mine Ore</i>         | 6,000  | 1.9    | 0.2    |
| <i>Birchtree Mine Ore</i>        | 4,000  | 1.4    | 0.2    |
| AS4 (Scavenger Tailings)         | 7,770  | 0.2    | 0.01   |
| SC4 (Scavenger Cleaner Tailings) | 1,200  | 0.6    | 0.03   |
| A2 (Ni Concentrate)              | 1,000  | 14     | 0.3    |
| A3 (Cu Concentrate)              | 30     | 3      | 20     |

*Figure: Manitoba Operations Typical Flotation Assays*

## **Rougher Flotation**

The rougher circuit is two parallel lines consisting of 3 tank cells each (5A, 5B, and 5C or 6A, 6B, and 6C). Before reaching the rougher circuit CMC, PAX, CuSo<sub>4</sub>, and MIBC are added at B10/B14. From these sumps, flotation feed is pumped into the rougher pothead and then gravity fed into the selected line. Rougher concentrate overflows into the launder of each cell and reports to C50 while the tails of each cell are gravity fed into the next cell and eventually report to C52. In the rougher circuit, soda ash is used as a pH modifier to ensure that the pH stays at the target of 10.2.

## **Rougher Cleaner Circuit**

The rougher cleaner circuit provides a secondary cleaning to rougher concentrate in order to reject additional pyrrhotite and rocks. This circuit takes place in 100 cubic foot Denver cells labeled 27C/D and 28C/D which are located in the southwest corner of the flotation floor.

Rougher concentrate is pumped from C50 to distributor #5 and is gravity fed to 27 and 28 banks. The concentrate of these banks reports to D20 and is sent to #1 distributor for the beginning of the copper/nickel separation circuit. Rougher cleaner tailings report to D22 and are gravity fed to C46 where they combine with the scavenger concentrate.

## **Regrind Circuit**

Rougher tails from C52 are pumped into Head Tank #3 and gravity fed into #6 cyclones which consist of three individual cyclone units. Overflow from these cyclones reports direct to B12 sump and underflow is sent to Ball Mill #6 for further size reduction and surface polishing. If necessary, you can bypass the regrind circuit completely by pumping directly from C52 to B12. If you utilize this system, the discharge from Ball Mill #6 reports to A12 and then B12 sumps.

#6 Ball Mill is dedicated to the regrind circuit. Its' main purpose is to polish the slimes and oxidized patches from particle surfaces and provide a minor size reduction to slurry passing through.

## **Scavenger Circuit**

The scavenger circuit consists of two parallel lines of three cells each (3A, 3B, and 3C or 4A,

4B, and 4C). Feed is pumped from B12 into the pothead and is gravity fed to the selected line. From here, scavenger concentrate overflows into the launder of each cell and reports to C46 sump while the tails are gravity fed to C48 which pumps to the sand plant or the tailings sump (D2). PAX and MIBC are added in the scavenger circuit at C52 sump.

### **Scavenger Cleaner/Re-Cleaner Circuit**

The scavenger cleaner and re-cleaners consist of two lines of Outotec tank cells (lines 1 and 2) with four cells in each (A, B, C, and D). Feed is pumped from C46 into the scavenger cleaner pothead located between the A cells which then distributed feed into the B cell of the selected line. The tails (also called SC4) report to B1 sump and are pumped to tailings via D2. The concentrate of line 1 is pumped to B3 sump and then to 1A while the concentrate of line 2 is pumped to B5 and 2A. These “A” cells are the re-cleaner cells so, from here, concentrate reports to B7 sump and then C32 and tails report back to the “B” cells of the scavenger circuit for more cleaning.

### **Copper/Nickel Separation Circuit**

This circuit consists of two sub-circuits: the separator itself and the copper cleaner circuit. The copper/nickel separator acts like a rougher circuit to fast float the majority of the copper. The tails of the separator then report to the copper cleaners (similar to scavengers) for further cleaning and copper recovery.

### **Copper/Nickel Separators**

The rougher cleaner concentrate (RCC) from D20 sump first has lime added to it to maintain a pH of 12.3. Then, it is pumped to the copper/nickel separators (13C and 13D banks) via #1 distributor. Concentrate from this process is gravity fed to C30 sump and then pumped to 12C bank for further cleaning. Tailings from the separators are gravity fed to D12 sump where they join the copper cleaner tails.

### **Copper Cleaners**

The copper cleaners are set up in a closed circuit with a counter-current configuration. This means that the concentrate from each stage reports to the next stage, but the tailings travel backwards (i.e. the tailings from the third stage move to the second stage). Only the final cleaner concentrate and the first copper cleaner tailings exit the circuit.

The first stage of copper cleaning takes place in 12C bank where the concentrate is gravity fed to D10 and the tailings flow to D12. The second stage of copper cleaning takes place in 12B bank. Lime is added to D10 to achieve the desired pH and facilitate good separation and, from D10, the slurry is pumped to the first cell in 12B bank. From this stage, concentrate is gravity fed to C28 sump and tailings flow back to 12C bank.

Third stage copper cleaning takes place in 12A bank where slurry is pumped from C28 to the first cell. The concentrate is sent to C20 where it is dewatered. The tailings, however, flow backwards to 12B bank for further cleaning.

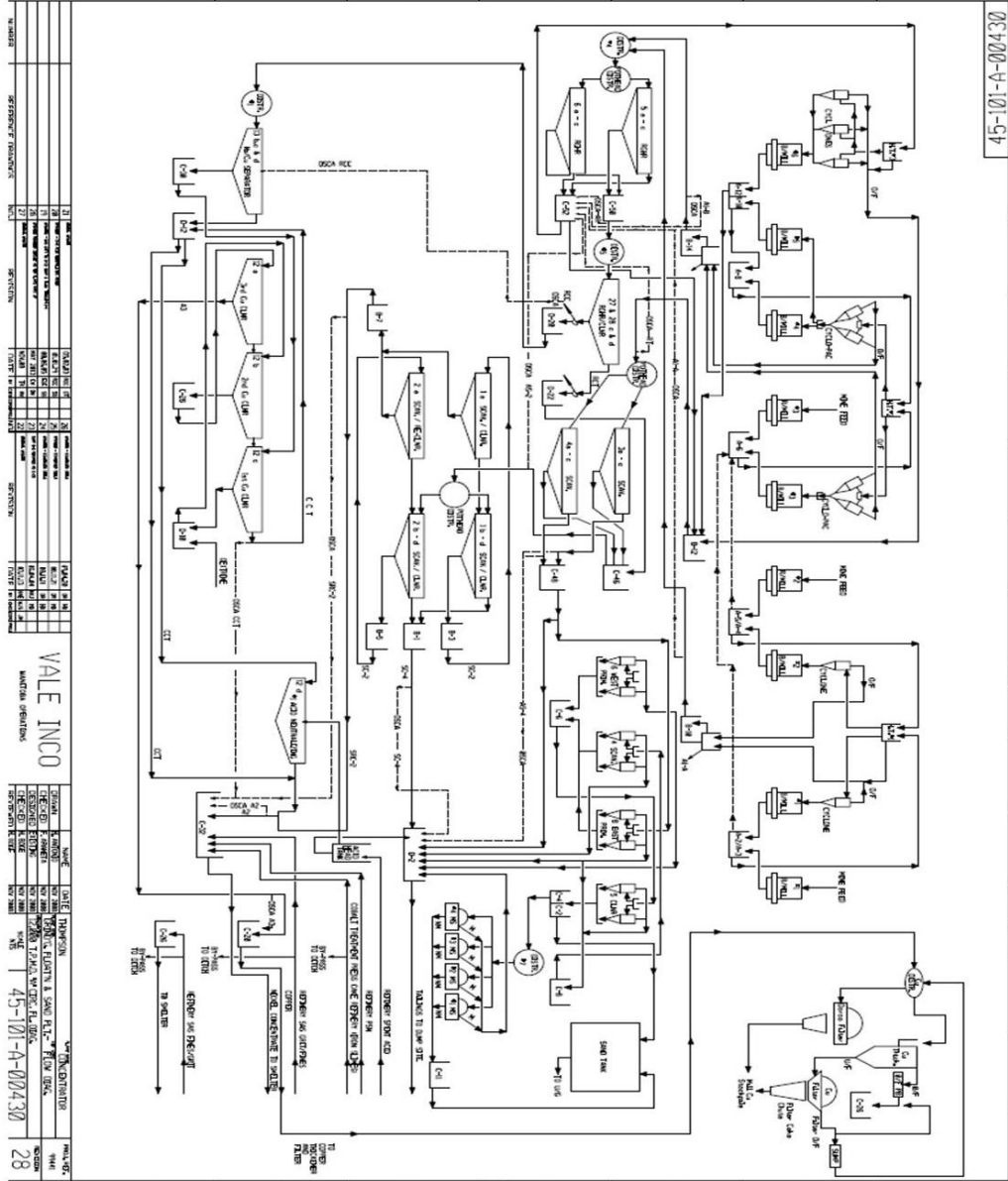

45-101-A-00430

Figure: Thompson Mill Process Flow document up to date for 2014.

### Mill Input/output Block Diagram

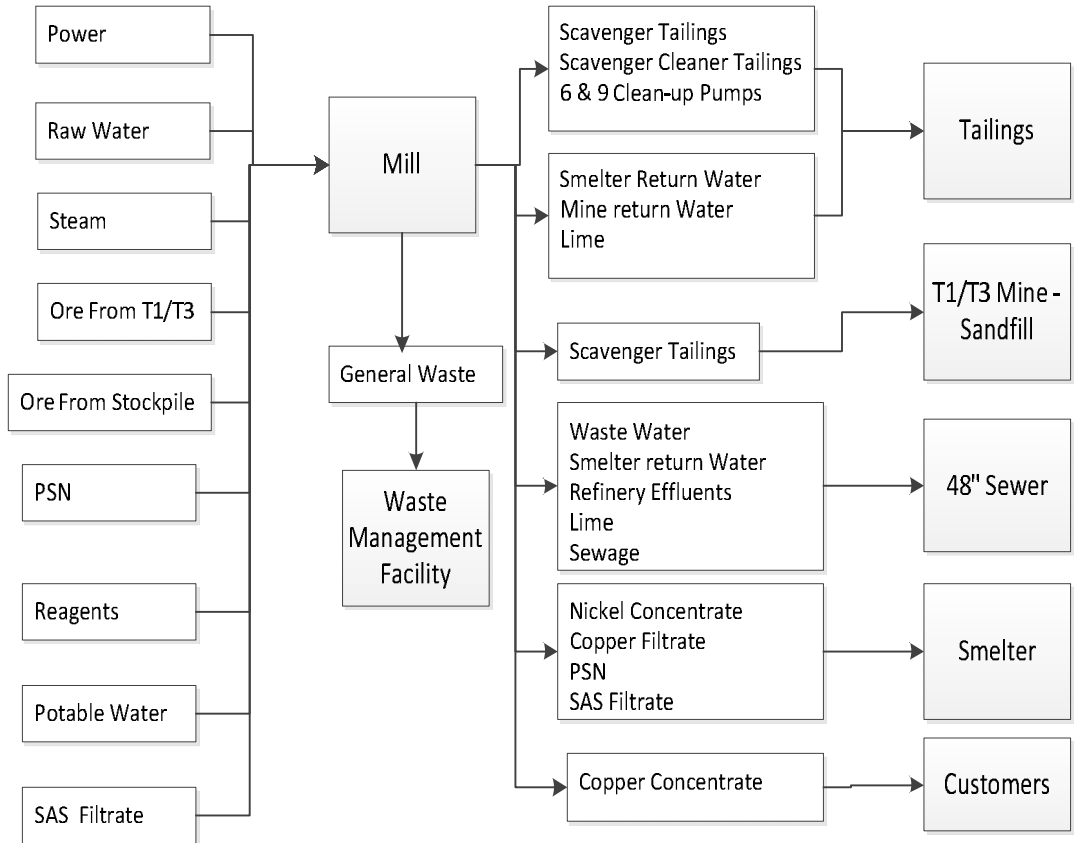

## 2.7 Smelter

The Smelter, with a workforce of 230 employees, processes nickel concentrate as slurry from the Mill, turning it into 570-pound anodes comprising 75% nickel. The Smelter typically produces 110 to 130 million pounds of anodes for processing in the Refinery.

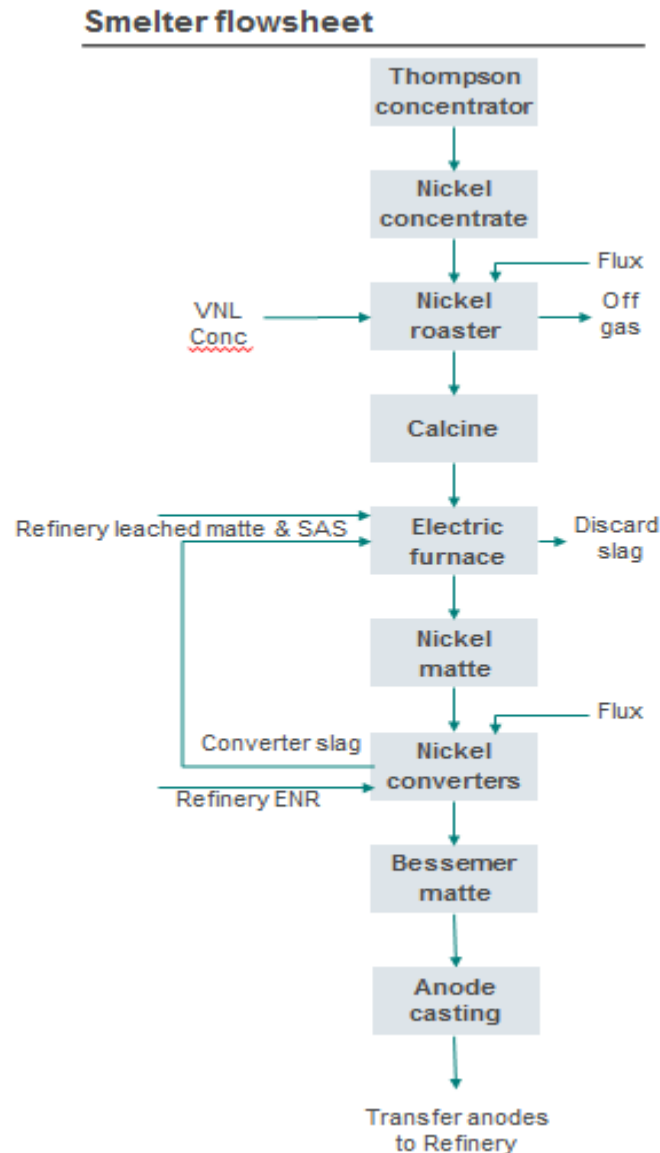

The smelter runs 24 hours per day, seven days per week. Nickel concentrate from the mill is dewatered and then processed through roasters, furnaces and converters to oxidize the sulphides, remove the iron and form Bessemer matte.

Nickel concentrate from the mill is dewatered in one high rate thickener which increases the solids content to 60-65%. A single pressure filter then increases the solids content to 90% producing a filter cake prior to entering the roasters.



The purpose of the roasters is to oxidize approximately half the concentrate's sulphur and its associated iron. As an autogenous process, all heat requirements are derived from the oxidation of iron sulphides. The roaster operating temperature ranges between 600 and 700 °C (1110 to 1300 °F) and is controlled by the rate of feed. A 60% silica flux is added to the concentrate in the form of sand in the roasters. Bed height is maintained at about 1.8 m (six feet) for maximum efficiency of the oxidation reaction. The resultant calcine is kept turbulent by injected compressed air. Ninety percent of the calcine is blown off as dust in the gases rising from the roasters. Cyclones collect the dust and send 85% of it to the furnaces by a drag system along with the 10% of roaster feed material that forms the roaster feed underflow. Of the 15% of the dust that escapes with flue gasses, 98% (design) is collected by an electrostatic precipitator (ESP) flue dust recovery unit. The off-gasses contain mainly nitrogen, oxygen, water vapour and 2.5% SO<sub>2</sub>.

Calcine dust, roaster underflow and dust captured by the ESP are carried by a drag chain conveyor to two submerged arc electric furnaces. The main smelting reactions are reduction of magnetite to ferrous oxide by unroasted iron sulphide and reaction of the ferrous oxide with the added silica to form an iron silicate slag. The furnace slag temperature is maintained at 1300 °C (2370 °F). A fayalite slag, containing iron silicates, rises to the surface. The slag is skimmed off, granulated and pumped to the slag disposal area. As the slag rises in the furnace, the matte containing 35-40% nickel and copper, as well as iron, sulphur and cobalt sinks to the bottom. The matte is tapped to ladles for transfer to the converting process.

Five air-blown converters accept matte charges from the furnace by ladle. In an autogenous process, the converters remove the iron by selective oxidation and slagging with more silica flux. Air is blown in through the bath at the back of each converter. The Bessemer matte product contains 76% nickel, 2.5 to 3% copper, 18 – 21% sulphur, 0.7% cobalt, some arsenic and about 0.5% iron. Sulphur is blown off as SO<sub>2</sub> and iron reports to the slag. All converter slag is returned to the furnaces for cleaning. The Bessemer matte from the converters is cast into anodes for the refinery.

## SAS

The Smelter receives 2 trucks per day of Sulphur Anode Shimes (SAS) (about 15-20 tons). SAS is a by-product from Electro-refining of anodes in the Refinery.

- Transportation hauls 2 trucks per day to the Fresh Sand pile in the Smelter South Yard.
- The rest of the SAS produced in the Refinery is hauled to the SAS Stockpile.
- SAS for consumption is blended at a ratio of 1 to 6 with Sand flux. Mixing of SAS and Sand is done by Front End loader.
- The blend is consumed through roasters and furnaces.

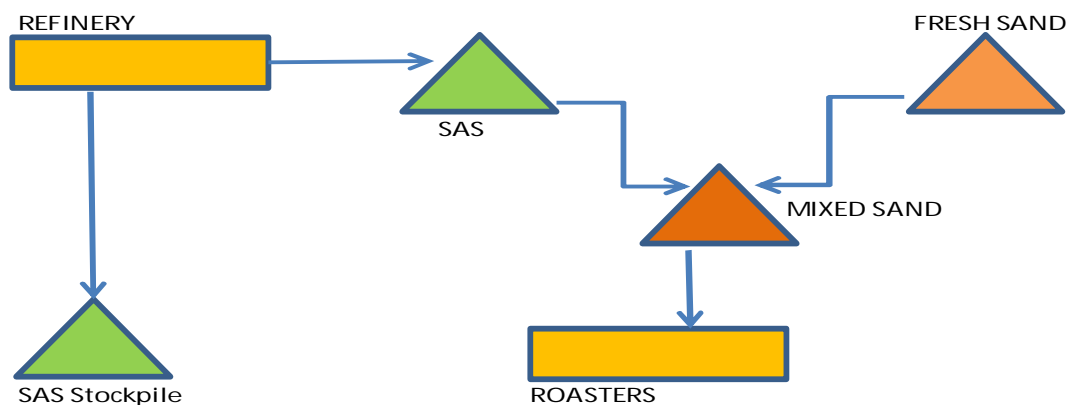

## Leached Matte

The Smelter receives 40-50 tons per day of Leached matte from the Refinery. Leached Matte is produced after spent anodes are crushed, milled and leached to replenish Ni in Refinery solutions.

- The Leached Matte is received in the MR Building which is in the south west of the Smelter.
- A vibrating screen operated by a contractor is used to screen the Leached Matte to – 4mm, with the undersize fraction being fed direct to the furnaces.
- The oversize fraction is size reduced using a Packer. Both the oversize and undersize are stored in the MR Building.
- Leached Matte for consumption is transported to a 20 ton box in the Converter Aisle using Front End Loader.
- The box is lifted by crane and set on a platform on the 4<sup>th</sup> floor.

- A Bobcat hauls the Leached Matte to a grizzly on the Leached Matte system from where it is conveyed to the furnaces by conveyors and drags.

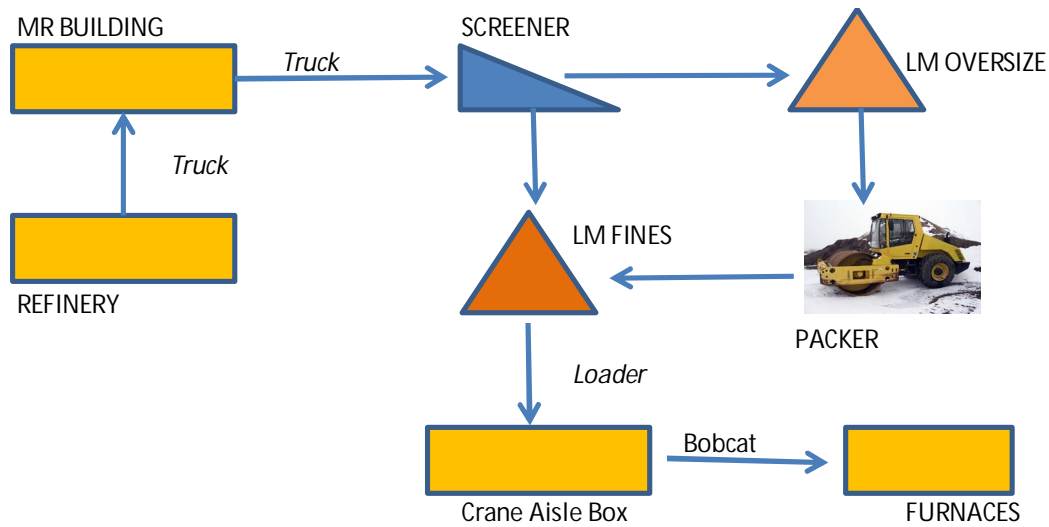

## ENR

The Smelter receives approximately 20 tons per day Electro-Nickel Reverts (ENR) from the Refinery. ENR is a by-product of the electro-refining process; it comes from the part of spent anodes which did not dissolve in the tanks.

- ENR is hauled by trucks to the ENR Bay adjacent to the VBN Building.
- Front End Loader hauls the ENR to boxes in the Converter Aisle - ready for crushing.
- A system of conveyor takes the crushed ENR to Converter Scrap Bins ready for consumption in the Converters.
- The target is to consume 20 ton per day.

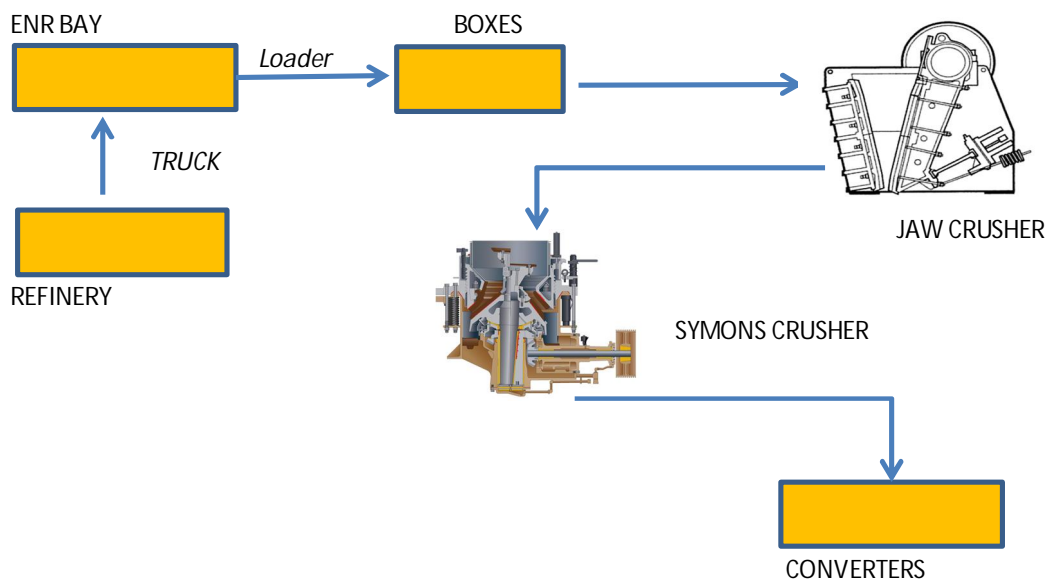

## Smelter Scrap

Smelter scrap is generated during transfer of molten materials between Furnaces, Converters and Casting line.

- Scrap is made up of build-up that sticks to tapping chutes, ladles, Converter mouth, casting tundish and spillages from handling of molten material.
- Scrap is crushed through the Traylor and Symons crushers before consumption in the Furnaces and Roasters.
- Dry scrap is stored inside for consumption in the Furnaces.
- Converters are able to take both dry and outside scrap.

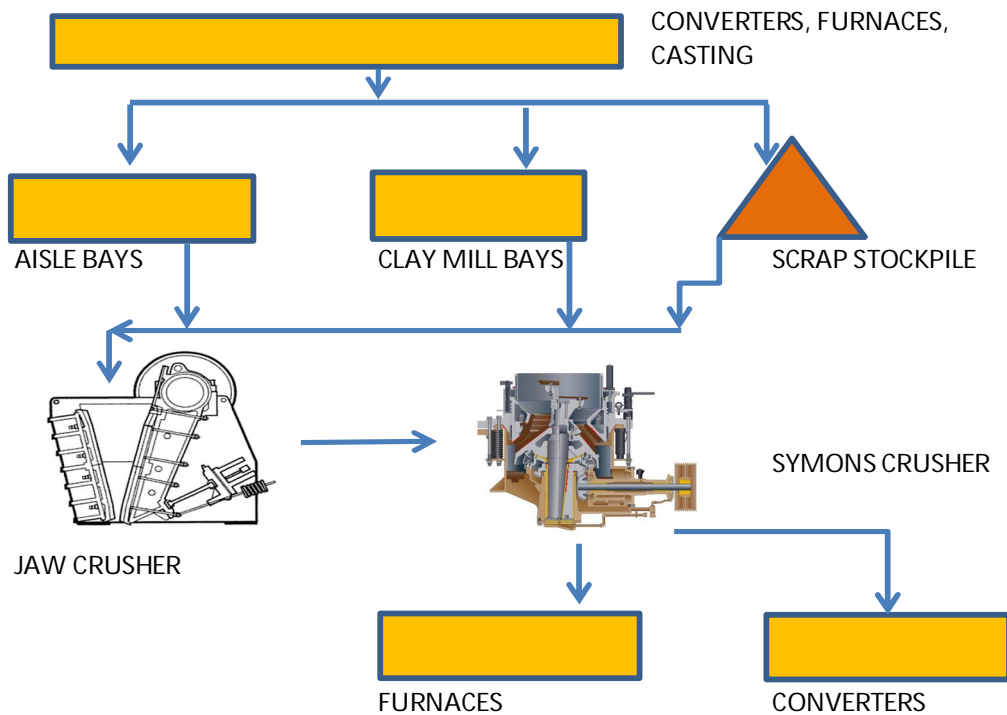

## Cottrell Dust

Cottrell Dust spillages are generated by process upsets in the Cottrell ESPs. Process upsets in the Cottrells cause build-up of dust in hoppers which must be removed by Vacuum Truck. This dust is blended with Leached Matte, VBN or Sand and fed back to the Smelter Process.

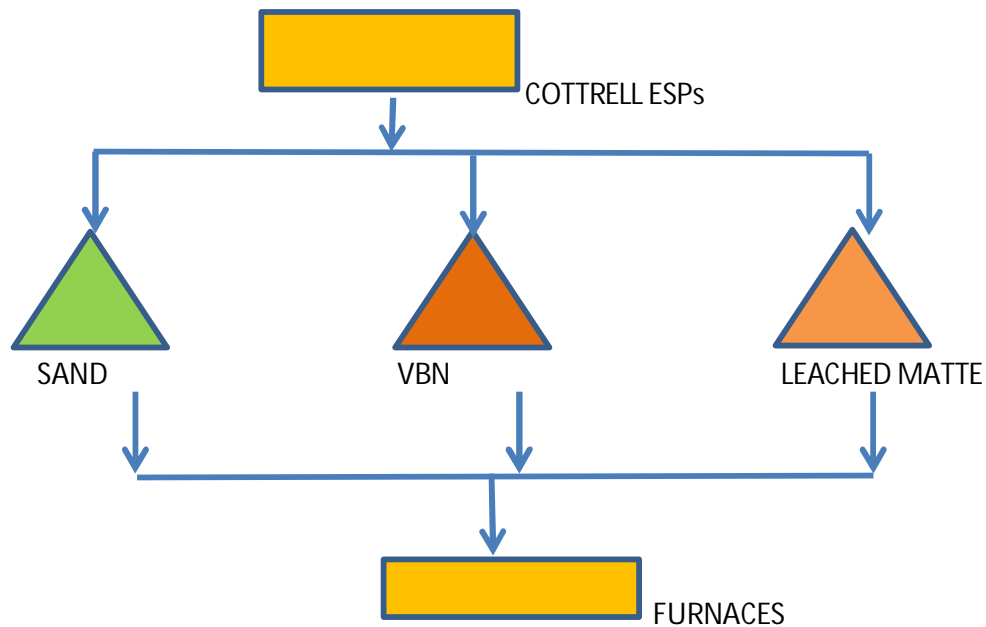

## Slag Disposal

Granulated slag from the smelting operation is pumped to a slag disposal area located immediately west of the smelter complex. Slag solids are deposited in a delta while the transporting water drains to a ditch along the toe of the delta. Slag is produced at a rate of approximately 450,000 dry tons per year.

Current stability issues with the slag pile relate to minor wind and water erosion and incursion of the toe of the pile into the seepage collection ditch. There are no reports of significant structural stability concerns.

# Smelter Input/output Block Diagram

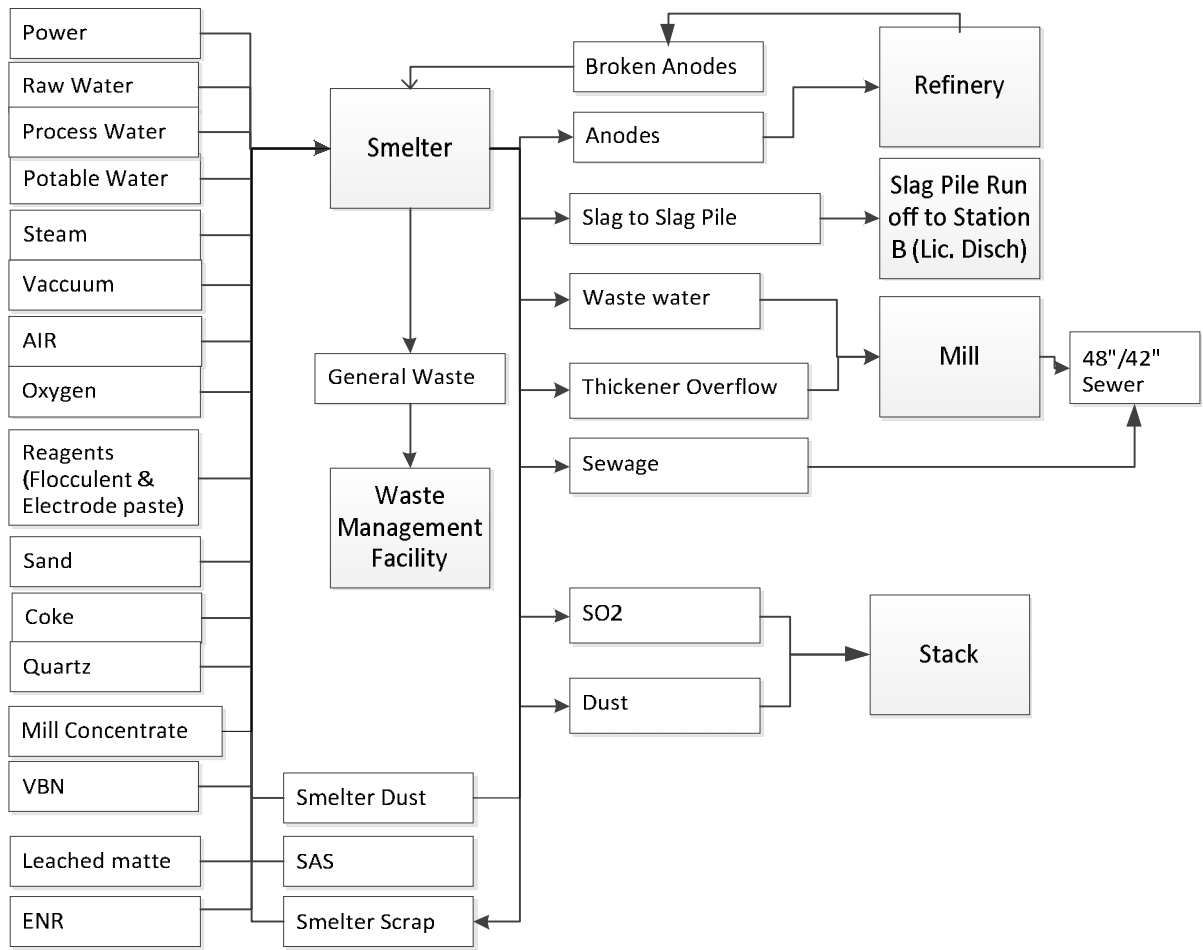



Smelter

Furnace

Converter Aisle

Slag

Thickener

ESP

Stack

ThawShed

Quartz Bldg.

South Yard

Warehouse Storage



## 2.8 Refinery

The Thompson Nickel Refinery was commissioned in 1961 as part of Inco's mining, milling, smelting, and refining complex in northern Manitoba. The refining process uses cast Bessemer matte anodes and produces a range of sheared cathode products and since 1984 has also produced S and R Rounds for the plating industry. The Thompson Nickel Refinery has produced a total of 3.15 billion pounds of electronic nickel and 21.5 million pounds of cobalt.

The Thompson Nickel Refinery was completed in 1960 and the first nickel was produced on 1961. The basic flow sheet was adopted from the Port Colborne Nickel Refinery. However, in the new plant metallic anodes were replaced with sulphide anodes, a practice piloted in the late 1950's at Port Colborne. The material of construction available in 1961 were limited to mastic lined plating cells and transite piping between vessels. A large portion of the tankage was of wood stave construction or refractory lined concrete. The first major change in material of construction came in 1967 when FRP liners were installed in the concrete plating cells. Since then, FRP had been the preferred material on construction for tanks, pipes, and liners, and on-going replacement of worn out items is with plastics or corrosion resistant, lined materials.

Another major change of 1967 was concerned with electrolyte purification. Previously, copper had been removed by cementation on nickel shot and arsenic was rejected as a basic ferric arsenate precipitate. In the new system hydrogen sulphide was used to precipitate copper and arsenic from the electrolyte and this was followed by a nickel replenishing leach of ground matte.

Other changes of 1967 included upgrading of general instrumentation and installation of the first centralized control room. Additionally, nickel hydrate, generated electrolytically was replaced with nickel carbonate, which is continuously precipitated from weak liquors using soda ash. Nickel hydrate had been used for combined cobalt iron hydroxide precipitation.

Until 1984, the principal product of the Thompson Nickel Refinery was full cathode nickel (28 1/2" x 40" x 3/8") and cut shapes. Then in 1984 the technology and production equipment for S and R Rounds production was transferred to the Manitoba Division from the Port Colborne Nickel Refinery. This took place within a period of four months, and in the fall of 1984, the Thompson Nickel Refinery became Vale's sole source of electro refined primary nickel product that is a 99.9% pure and suitable for nickel plating or melting to form alloys.

Productivity improvements have been a continuing and vital part of maintaining the viability of the Thompson Refinery. In 1983 microprocessor based instrumentation was installed resulting in improved quality control, increased stability in the process, and an ability to reduce the number of operators required to operate the purification areas of the Refinery. In 1986 a Total Quality Improvement Program began and further gains in process stability allowed additional productivity gains in both the Tankhouse and Purification.

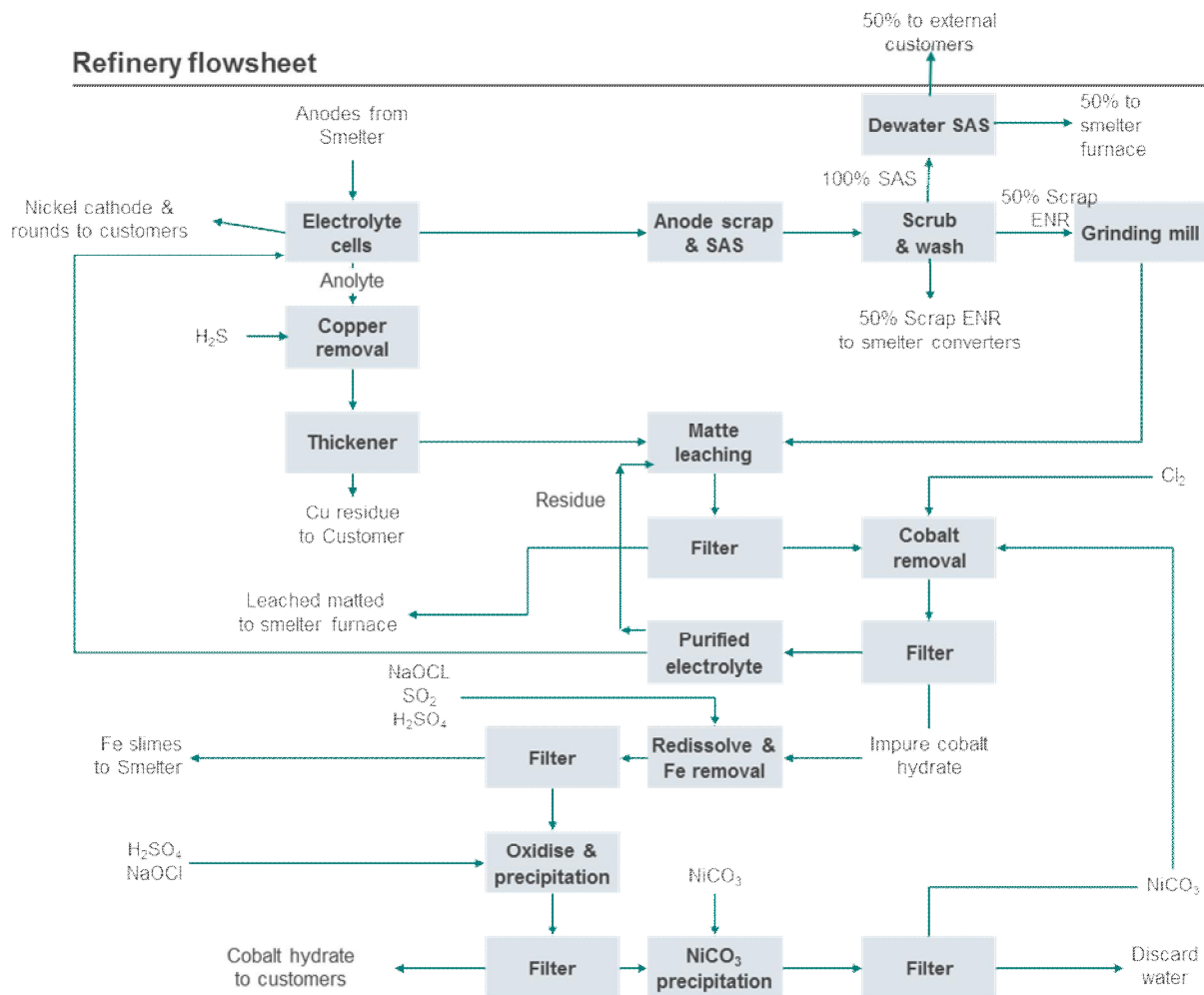

## Tankhouse Practice

At maximum capacity the TNR was able to produce approximately 80 million pounds per year of full cathode and 45 million pounds per year of Rounds, both S and R. As previously mentioned, the feedstock is Bessemer Matte anode cast in the Smelter. This anode is about 75% nickel, 2.5 to 3.0% cobalt, 0.8% copper, and 20% sulphur. The anodes weigh 525 pounds. After 16 days in the Refinery plating cells the remainder of the anode, approximately 25% of the original nickel containing matte, is scrapped. The sulphur anode slimes are washed off and reverted to the Smelter. The balance of the material is crushed and ground becoming a feed for the leach train nickel replenishment system.

Because of the large amount of sulphur slimes produced during the dissolution of the anode, each anode is contained in a loosely woven polypropylene bag. The cathode compartment consists of a wooden box frame covered with a stretched diaphragm cloth of acrylic fibre held in place by a spline and groove. This is essentially the same design of box in use since 1961, with the exception that the current masking aspects of the box and the physical dimensions have been changed to improve the control of edge growths and to assure the centering of the cathode. Although various designs of plastic frames and permanent boxes have been developed and evaluated, the wooden cathode box with a stretched diaphragm

still appears to be the most reliable, cost effective method of creating a cathode compartment.

If the final product is full cathode nickel, the cathode is a nickel starting sheet. If the final product is Rounds a stainless steel mandrel covered by a heat set epoxy masking with circular areas of steel exposed to plating is used. Purified electrolyte is fed into each compartment so as to maintain a positive head in the cathode box and a net flow of electrolyte through the diaphragm in the anode compartment. Electrolytic nickel is produced on a 10 day cycle for full size cathode and 5 days for S and R Rounds. The plating cells are serviced from a mobile crane platform which is used to manually change single anodes or cathodes.

Starting sheet preparation for the full sized cathode is a manual process. The starting sheet is removed from the stainless steel blank by hand, sheared to the proper size, pressed with embossing, and equipped with welded suspension lugs.

### **Purification Practice**

The major impurities removed are copper, arsenic, iron, and cobalt. In 1983 a Foxboro Videospec Process Controller was installed, and upgraded again to a Foxboro Intelligent Automated System in 1990. This has been constantly expanded in 2006 extended to Cobalt Purification and Nickel Carbonate areas of the process. The equipment provides increased efficiencies and decreased deviations in the purification operation. The improved process control has yield an increase in reagent efficiency and has contributed to increase manpower productivity. The automated system along with intensive training efforts, directed at all levels of refining operations, coupled with improved communication systems (2 way radios), has greatly improved the work environment, and incidences of imperfect process control have decreased.

### **Removal of Copper and Arsenic from Electrolyte**

Copper is removed from the anolyte solution by reaction with hydrogen sulphide. As the copper is precipitated, and due to the comparatively high concentration of nickel and the favourable pH of the electrolyte, some of the nickel will be precipitated. It is desirable to remove as much of the copper and arsenic and as little nickel as possible. Instrumentation controls the oxidation reduction potential to the ideal set point.

Physical removal of copper-arsenic-nickel precipitate is as important and as difficult as chemical removal. After contacting the electrolyte with hydrogen sulphide in a venture contactor, the slurry is conditioned in a reaction tank. The slurry is then settled and thickened in three parallel forty foot diameter thickeners. The clear overflow is pumped to the matte leach train, and the underflow is filter washed to remove soluble nickel.

Between 1972 and 1980 a kiln was operated on site to dry this product with a portion of the material being shipped off site for metal recovery at other metallurgical facilities. The kiln and the entire associated infrastructure have subsequently been removed. From 1985 to 1999 all copper precipitate from the Refinery was directly injected in to the fluid bed roasters in the Smelter copper circuit and the copper ingots were transported to Sudbury's Copper Smelter. The processing of copper- arsenic has been a challenge and over the years an

infrastructure was required to accept process overflow. Over the life of the Thompson Mine Site five HDPE lined copper-arsenic residue storage ponds have been constructed. Vale has had an on-going program to recover the copper-arsenic residue. Product in two of the five ponds has been recovered and the ponds decommissioned.

### **Removal of Cobalt and Iron from Electrolyte**

Cobalt and iron are oxidized and hydrolysed using gaseous chlorine and basic nickel carbonate. To reach the low concentrations of cobalt required, the pH must be raised causing larger amounts of nickel to precipitate.

Cobalt hydroxide is removed by filtration in eleven plate and frame filter presses operating in parallel. The press cake is emulsified with water in the emulsifier tanks, and is pumped to the cobalt purification department for where the cobalt, iron, and nickel are separated and cobalt hydrate is the final product. The filter press filtrate is then passed through scavenger presses to ensure no solids are carried to the Tankhouse.

Between 1961 and 2006 the finished product was cobalt oxide which was shipped to Vale's facilities in Clydach, Wales to be processed into final products. In 2006 a major capital investment expanded the cobalt purification department to accept increased levels of cobalt in anode from Voisey Bay feed and improve environmental aspects of handling cobalt oxide. The final product from cobalt purification is now cobalt hydrate which is shipped to Port Colborne for further processing into electrolytic cobalt and a customer in the United States that processes cobalt into many end uses for other industries.

### **Manufacture of Nickel Carbonate**

The nickel carbonate used for pH control during cobalt removal is produced by reacting nickel in dilute wash liquors with a saturated soda ash solution.

The nickel carbonate process also controls the Refinery salts balance and provides water removal. For environmental and economic reasons all spillage, containing soluble nickel, is returned to the process stream. Similarly, most of the water used in the building is returned. Water that is used in closed circuits such as cooling water that does not touch the filtrate is not added to the process. Water that is used to transport the sulphide anode slimes to the Mill is treated with lime, in the Mill, to recover the soluble metals. Water used to wash cobalt hydrate is directed to sewer as soluble metals are minimal at this point. Water is used throughout the Refinery for washing filter cakes to remove soluble nickel, to lubricate and cool pump shafts, to remove salt build-up and for general housekeeping.

Water must be removed from the circuit to maintain a constant electrolyte volume. Water removal is accomplished in two ways;

- i) Natural evaporation in the Tankhouse.
- ii) Removal of water during nickel carbonate production.

The electrolyte also contains sodium, chlorides and sulphates due to the reagent additions during electrolyte purification. None of these ions plate out in the Tankhouse. If they were not removed in the nickel carbonate process their levels in electrolyte would continually

build-up. At higher concentrations, the solubility limits in electrolyte could be exceeded and “salting out” could occur.

Large changes in the concentrations of these ions can affect the quality of the plating by altering the conductivity of the electrolyte, the hardness of the nickel and some plating characteristics of nickel.

### **Maintaining the Nickel Balance**

The nickel content of the electrolyte is continuously depleted due to anode dissolution inefficiencies, physical removal from the circuit as co-precipitated solids with impurities, and soluble nickel left in filter cakes. Other metals removed from solution during purification must be replaced by nickel as well.

For every 100 pounds of nickel plated in the Tankhouse, only 87 pounds of nickel is dissolved from the anode. All of these losses have to be replaced at the leach train, where ground spent anodes are leached with air and sulphuric acid.

### **Reagents**

The Refinery, as part of its refining process consumes various types of reagents. Consumption rates are dependent on nickel/cobalt/copper production rates and anode impurity levels.

# Refinery Input/output Block Diagram

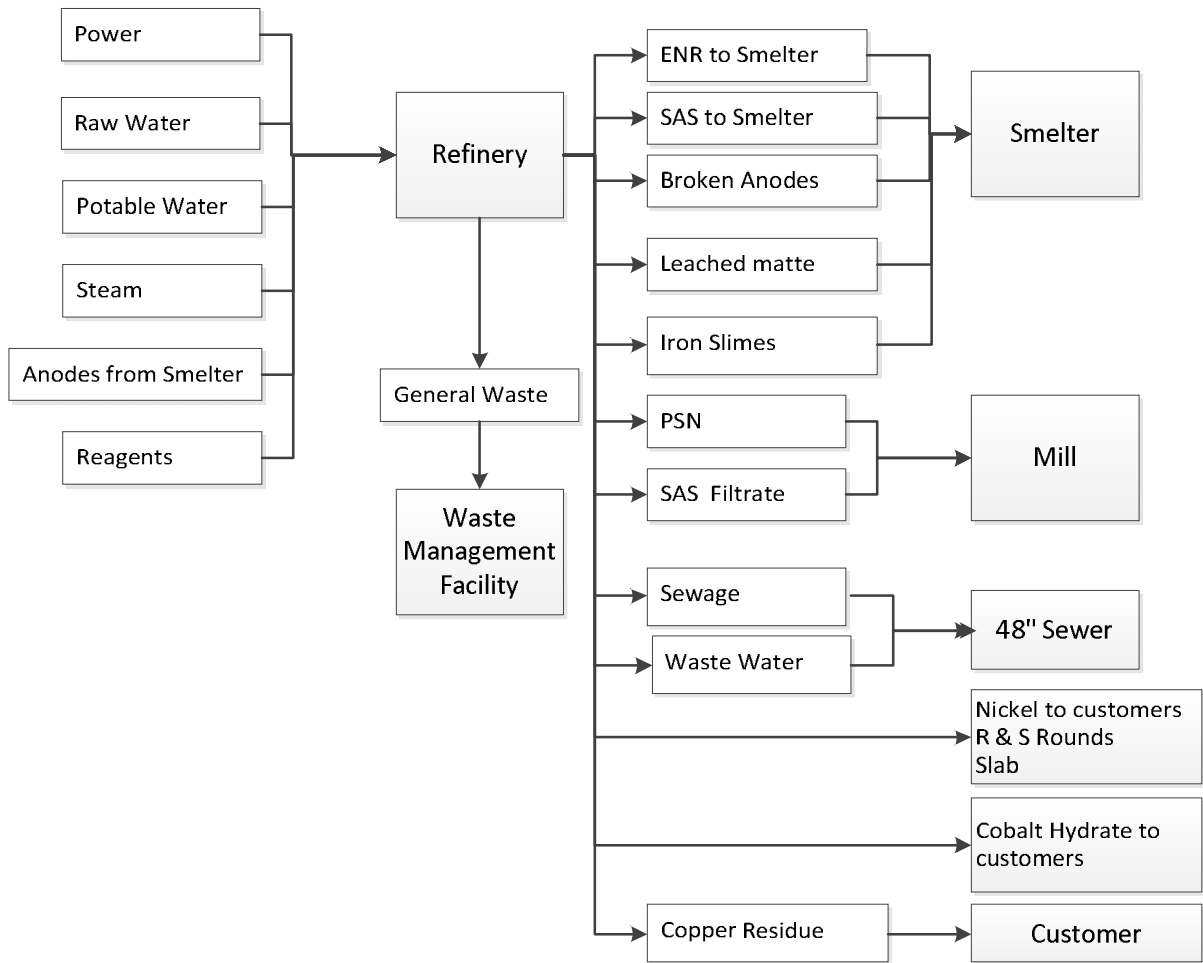



SAS

Rounds Shipping

Scrapwash

Tankhouse

Office

Cobalt

Purification

ShearShed



## 2.9 Utilities & Water Infrastructure

Utilities is the Plant distribution for:

- Power (155 million watts) Power distribution: Utilities supplies 13,800V power to Vale Thompson Operations. Utilities transforms the power from MB Hydro from 138,000 V to 13,000V, 4,160V and 600V. Note the schematic drawing for the Primary distribution system comprises of over 12 D sized drawings.

### Water Treatment Plant

- Water Treatment Plant (WTP): produces potable water for the City of Thompson (approximately 1500 gpm) and Vale Thompson Operations (approximately 750 gpm). Main equipment of the WTP is 2 each SCU, 1 Rapid Mix, 10 filters, 4 water reservoirs with a total capacity of 2M gallons and associated pumps, piping and chemical systems
- Currently Vale owns and operates the WTP; however the City of Thompson will assume full control in the near future. A plan for transition of the asset to the City of Thompson is in place.
- 4.5 million gals/day capacity to treat water
- Approx. 2 million gallons/day provided to the City
- Approx. 1 million gallons/day to Vale
- 2 solid contact units
- 2 rapid mix units
- 10 mixed media bed sand filters
- 4 x 500,000 gallon storage units
- Manned dayshift only and remotely monitored from utilities 24/7/365

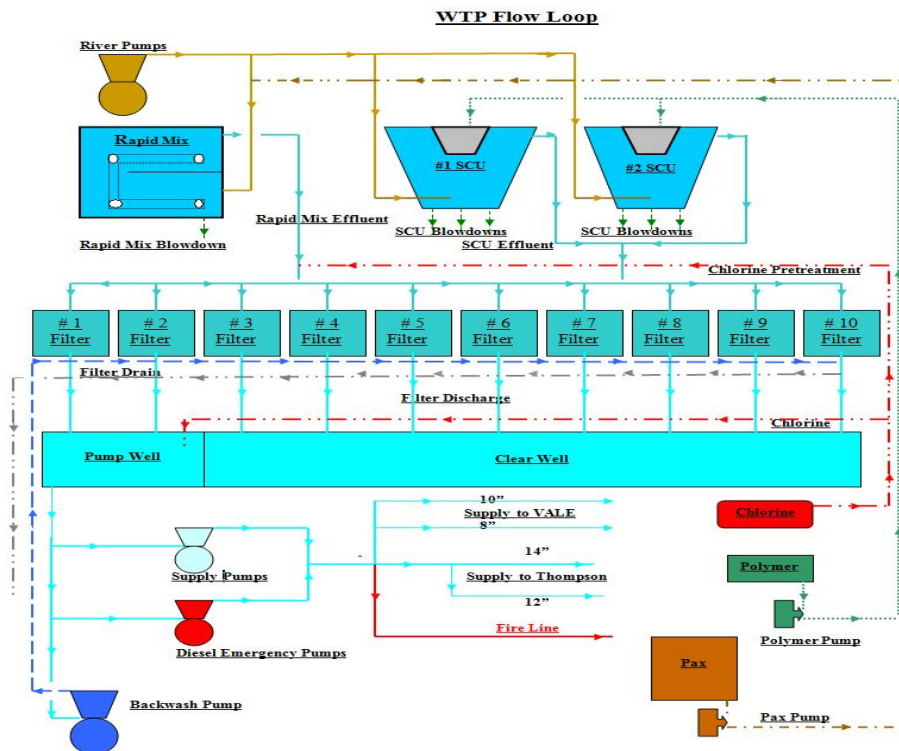

Potable water (1 million gallons) Potable Water: The potable water for Vale Thompson Operations is supplied via two potable water pipes with 10" and 8" diameter. The potable water is then distributed to site and process via 4 booster pumps and a potable water tower

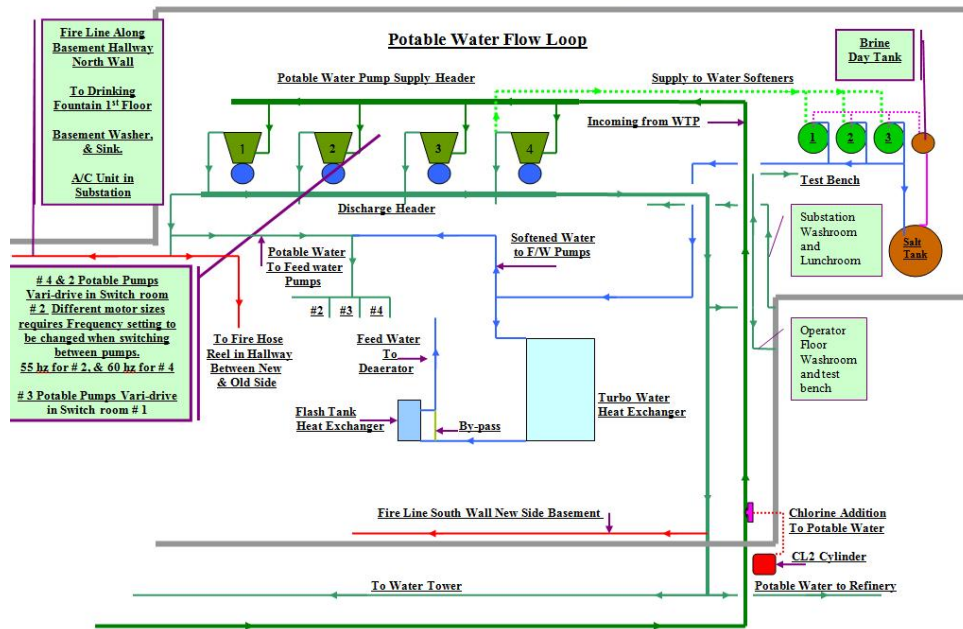

- Process water (28,000 gals/min): Process Water: 4 each vertical turbine pumps pump raw water from the Burntwood River to Water Treatment Plant and Vale Thompson Operations at a rate of approximately 15,000 gpm via two process water lines of 36" and 24" in diameter. The process water is distributed to site by 8 process water booster pumps at a pressure of 100 PSI. The process water is also used for cooling equipment in Utilities Building

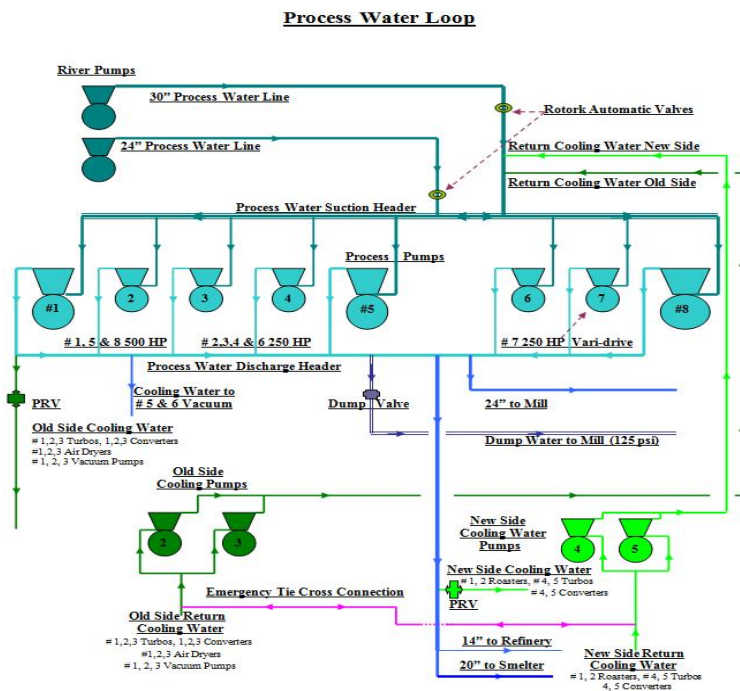

Cooling Tower: All equipment on the South side of Utilities is cooled by a Cooling Tower operating on potable water

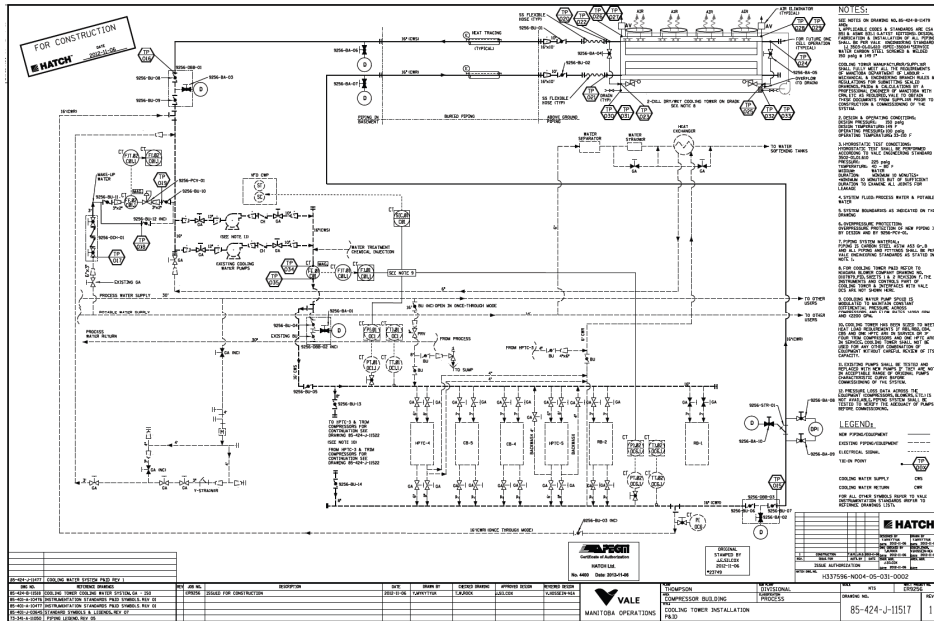

- Vacuum (6,000 cfm @ 29") Vacuum: Utilities supplies vacuum to Vale Thompson Operations using 5 vacuum pumps

**Vacuum Flow & Tanks**

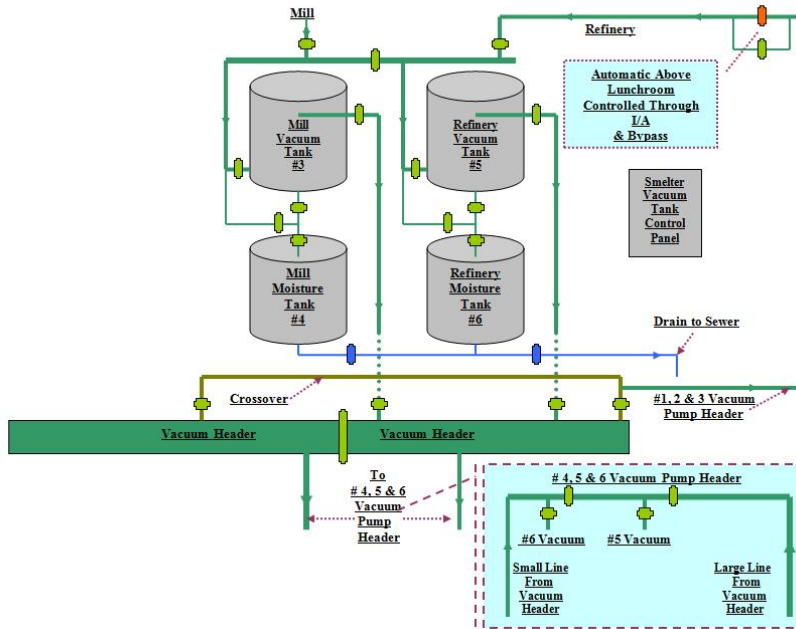

- Compressed air (24,000 cfm @ 100 psi) 100 PSI air: Utilities supplies 100 PSI air to Vale Thompson Operations (except BT Mine). 100 PSI air equipment consists of two large turbo compressors (Brown Bowery) with 18,300 CFM and 24,000 CFM capacity, two medium size compressors (Ingersoll Rand) with a 10,000 CFM capacity each and 4 small size compressors (Sullair) with a capacity of 2,200 CFM each

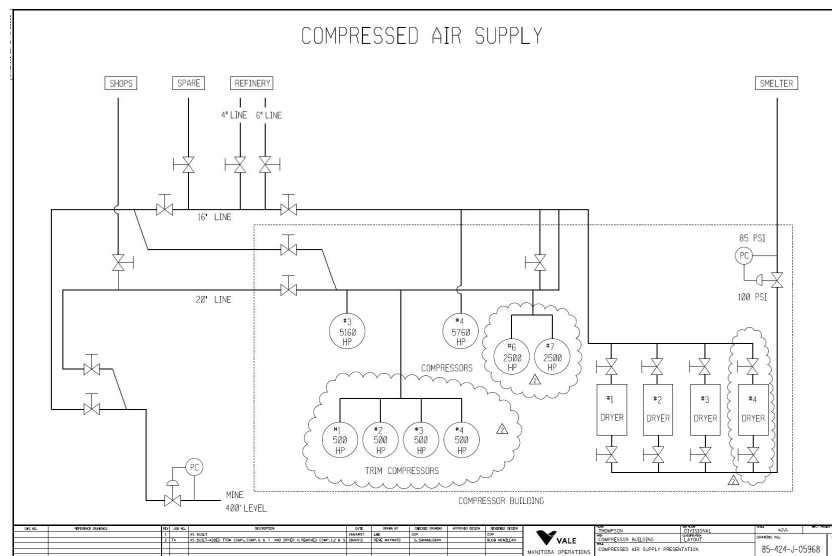

- Instrument air Air Dryers: Utilities supplies dry air to the Smelter and the Mill. Utilities is using 4 each air dryers for this process (see drawing 85-424-J-05968 attached).
- Roaster air (50,000 cfm @ 8 psi) 8 PSI air: Utilities supplies 8 PSI air to Smelter Roasters. 8 PSI air equipment consists of 1 Brown Bowery blower with a capacity of 75,000 cfm. Roaster air can also be supplied from the Converter Air by using an automatic valve that adjusts the pressure from 15 PSI to 8 PSI.
- Converter air (80,000 cfm) 15 PSI air: Utilities supplies 15 PSI air to Smelter Converters. 15 PSI air equipment consists of 3 Brown Bowery blowers with a capacity of 50,000 cfm each.

- Steam (120,000 lbs. /hr.) Steam: Utilities supplies 90 PSI steam to Vale Thompson Operations (for heating and process) using 14 electric boilers, a de-aerator and associated equipment
- Condensate is returned from the Surface Dry and the Mill to the Utilities. All other areas the condensate is discharged to sewer

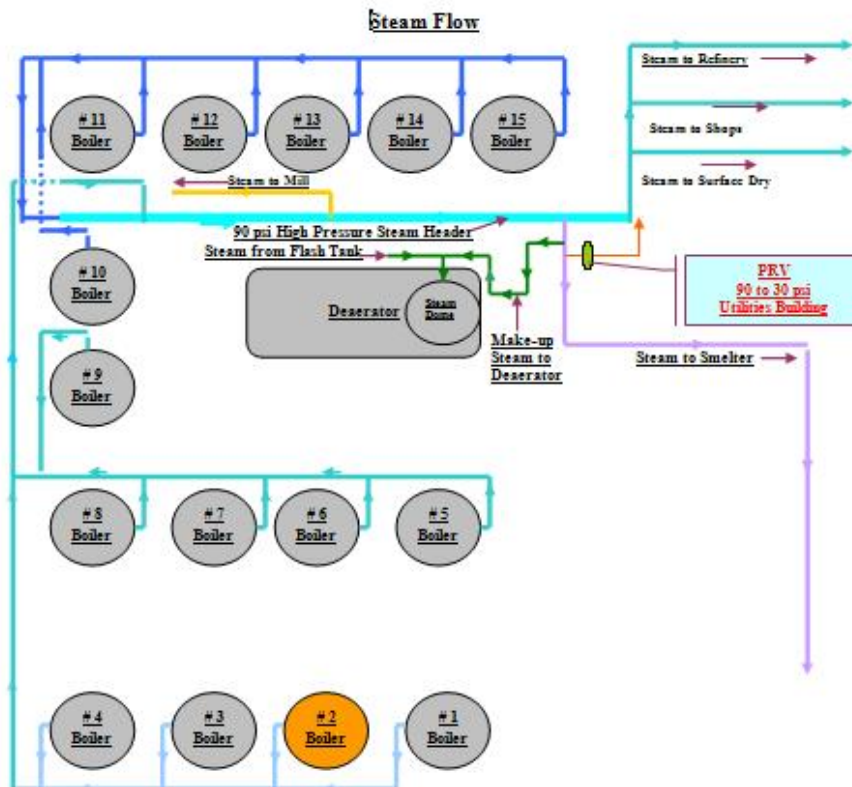

There are 15, 600Volts, 10,000 LBS/hr boilers.  
 #2 boiler is not operational.

## **2.10 Ancillary Infrastructure**

The Ancillary infrastructure consists of a number of different buildings which provide office, space, maintenance facilities, warehouse, heated storage and cold storage for the site. The majority of these buildings are shown on the attached site plan

### **2.10.1 Site Security**

- This consists of a main guardhouse and a weigh scale operation.

### **2.10.2 General Office**

- Primary office space for Administration, HR, Accounting, Engineering, Laboratory and other general services.

### **2.10.3 Maintenance Shops**

- Provides Office space, Electrical shop, Carpenter shop, Rubber shop, Sandblasting, Paint shop, Mobile Equipment Garage, Machine shop, Welding & fabrication shop, Rigger shop, Open pit garage, Large annealing furnace, Inventory yard.

### **2.10.4 Warehouse and Traffic**

- Provides office space, Shipping and receiving of material, Heavy storage area, Light storage area and is a Central distribution point for equipment and other items throughout the operation.

### **2.10.5 Fire Hall and Transportation**

- Provides offices, lunchroom, Fire truck & rescue vehicle, Oxygen refill center for breathing apparatus, Grader, loader, 5 ton boom truck, sweeper, bobcat, flat deck truck, dump truck.

### **2.10.6 Valer Building**

- The primary purpose of this building is as a training facility for all personnel on site. The building consists of offices, Classrooms and video conference systems. The building also houses the record storage for the plant site.

### **2.10.7 Surface Dry**

- This building houses the clothing change and shower facilities for the personnel that work in surface operations. It also houses the Gym and First Aid for the site.

### **2.10.8 Thaw Shed/Copper Concentrate Tents**

- Originally the Thaw Shed building was used to thaw product in rail cars from Pipe and Soab Mines. Currently it is used in conjunction with the temporary structures (Copper Concentrate Tents) for storage, preparation and shipment of copper residue. Any surface run off reports to the tailings basin.



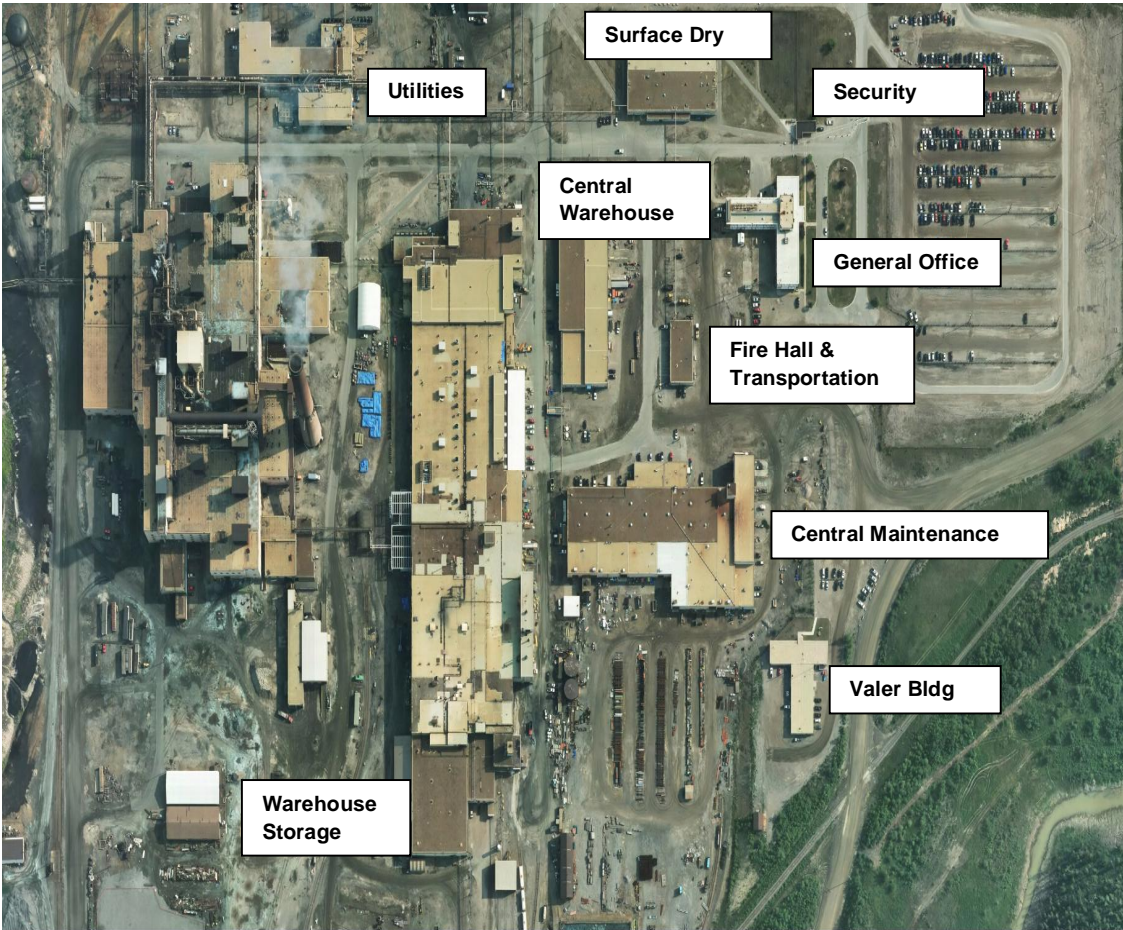

For the above facilities, the solid waste is collected and transported to the Waste management facility for processing. Sewage and waste water are disposed of via the 48" and 42" sewer eventually being deposited in the Tailing basin



### **2.10.9 Haulage Contractor on Site Building**

A local contractor provides haulage services to Vale Manitoba Operations. These services include:

- Haulage of ore from Birchtree to the Mill and Stockpile
- Haulage of waste rock for Birchtree
- Haulage of waste rock from T1 to the waste rock pile
- Haulage of ore from T1 to the Stockpile
- Waste Rock crushing and screening
- Production and haulage of quartz from Manasan quarry

To provide onsite minor repair services of their equipment at Vale, the Contractor has a maintenance shop on site (located south of the open pit).

### **Waste Management**

The facility utilizes Port-a-Potty for their employees which are managed by an external contractor. The waste is collected and disposed on a regular basis.

Oils and grease is stored in minimal quantities with used/waste oil being stored in drums and transported back to the their offsite facility for disposal.

Water is provided through use of bottled water. The full bottles are transported to the Vale site by Contractor employees. The empty bottles are collected within the building and returned to their offsite facility on a regular basis.

## 2.10.10 Orica Operations

All activities conducted within the Orica site boundary (where Orica has operational control) involve the Manufacturing and Storage of:

- AMEX
- Packaged Explosives
- Ammonium Nitrate Prill
- Misc bulk products stored on site

### Storage of:

- Liquid materials storage and dispatch: diesel, gasser solution, AN solution Fuels, Glycol, other bulk fuels, Gray water/ waste, surfactants
- Solid material storage dispatch including AN Prill, ANE, Sodium Nitrate, Sodium Nitrite

### Other:

- Workshop including: Maintenance / repairs to vehicle and plant equipment, flammables store, maintenance waste product storage
- General support area's (administration, amenities block)
- Waste management (including waste water collections, sewage)

The Thompson site is a part of the North American Mining Services business. The site has been established to service customers in the Northern Manitoba region of Canada which are a part of the Vale customer mine site. The site is manned by 5 people (full time) utilising 3 light vehicles.

The site is a manufacturing, storage and distribution facility. All products on the site are in a form which is supplied and able to be used direct on the customer site through Orica's Mobile Manufacturing Unit's (MMU's).

Orica Product Supply - ANE / AN Prill

Bulk materials (AN Prill) in their final form are obtained from Orica Manufacturing sites (AN Prill from Carseland). They are transported to site via AN Prill on B-trains. A maximum quantity of 55,000 kg of AN Prill bulk is able to be stored on the site. These materials are transferred into storage vessels on site.

Contract Product Supply - Diesel

Diesel is supplied to site directly from the supplier with a total of 25,000 L of Diesel being able to be stored in the site's tank/s.

The land on which the Thompson site conducts its operations is owned / leased by Vale. All assets within the Orica fenced area are owned and operated by Orica with the exception of the magazine which is owned by Vale.

History

1968 Manufacturing and bagging plant built in Thompson by ICI

- 1989 INCO and ICI signed long term explosives supply partnership agreement
- 1991 Official opening of the ICI Explosives Canada modern on-site explosives plant to manufacture and package AMEX II and other ANFO blends. Site operating under a business partner name of NuWest Explosives.
- 1998 ICI Explosives became Orica Canada Inc.
- 2004 Underground Fuel storage upgraded to above-ground to meet provincial standards
- 2009 Plant upgrade to incorporate equipment which enabled production of additional products.

Environmentally hazardous material is managed in accordance with:

- Relevant Dangerous / Hazardous Goods requirements
- Local regulations and requirements
- Relevant Engineering standards and guides
- Orica Model Procedure requirements outlined in the SHEC Management System

The site does not have any point source emissions from stacks (including boilers) pressure relief devices with vents, or process vents which require specific management.

Fugitive emissions and odours have not been identified as a significant environmental aspect for the site based on the type of activities which the site completed. Fugitive emissions and minor odours may arise from tank filling, venting of tanks etc. The site is manned at all times during loading and unloading of materials / products which ensures a high level of awareness of any potential impacts while activities are undertaken on the site.

### **Office & Amenities**

Grey water is directed into the onsite septic tank. The tank is pumped out by contractor as every two weeks.

### **Process / Bunds**

Wastewater generated in the plant (in equipment or floor) from cleaning/wash down/rain, or liquids collected in the bund are collected in a septic tank. The process/effluent waters are sent to one tank and the septic tank waters are sent to another. The tank is pumped out by a local contractor as required and deposited into the City of Thompson Waste Treatment System.

Storm water is generated from area around the bunded tanks and any bunded process area (this includes loading area for bulk raw materials). The waters from these areas are contained in a catchment area which is then pumped out into two IBC tanks. The tanks are then pumped out and disposed of by a licenced waste company. The collection of the stormwater in tanks ensures no stormwaters leave the site. Water is collected in the effluent water tanks.

Soil and groundwater on the site are managed through a multi-tier approach. Waste is managed on the site in accordance to the waste hierarchy. Where possible waste is ELIMINATED, MINIMISED, REUSED or RECYCLED prior to General Disposal. The site maintains waste procedures to ensure that hazardous waste (including explosive waste) is tracked and all waste is appropriately managed, treated or disposed of.

| Waste Source    | Management   | Destination of Waste   |
|-----------------|--|--|
| Domestic        | All removed from site by contractor  | Approved Landfill  |
| Oil & Grease    | Waste materials stored in dedicated waste containers   | Prescribed waste provider (licenced)                           |
| Explosive Waste | Collected in dedicated & secure waste containers on site and transported on vehicles with appropriate dangerous goods licences to the Coniston site for disposal | Destroyed by Orica through the Coniston site by burning ground |
| AN & ANE        | Collected in dedicated & secure waste containers on site and transported on vehicles with appropriate dangerous goods licences to the Coniston site for disposal | Destroyed by Orica through Coniston site by burning ground     |

Note: The Thompson site transports Explosive and AN/ANE waste on licensed dangerous goods vehicles to the Coniston site. They have a license which allows them to receive prescribed waste from the Thompson site.

### **Amenity Impact Management**

The site has not identified any amenities which require any specific environmental management. Plant appearance, noise, vehicle movement, lighting and cultural heritage were all assessed in the site's aspect and impact assessment.

### **Raw Materials use Management**

The site is not a water or energy intensive site, and does not generate any significant impacts due to greenhouse gases.

### **Monitoring and Measurement Requirements**

The site currently does not undertake an active environmental monitoring program.



## **2.11 Transportation and Logistic**

*Vale Canada Limited has long-established relationships with road, rail, and ocean transportation providers.*

### **Road**

- All-season paved public highway from Thompson to Winnipeg covering 800 km
- Winnipeg is on the Trans-Canada highway with access to other major Canadian centers and the Canada-USA border to the south of the Province
- Cross-dock facility in Winnipeg used to transfer from road to rail for transit to coasts
- Road transport typically used for shipments to USA

### **Railway**

- Winnipeg sits at the junction of Canada's two Class 1 railways: Canadian National and Canadian Pacific. Both lines run to ports on the east and west coasts of Canada providing low cost transportation alternatives
- A short-line, operated by Omnitrax, runs from The Pas through Thompson to the seasonal Port of Churchill

### **Port**

- Finished product currently ships in 20 ft. ocean containers from the Ports of Vancouver, Montreal and Halifax to overseas markets
- Concentrates can also be shipped to bulk handling facilities at Vancouver, Montreal and Halifax as well as the Ports of Quebec City, Prince Rupert, Trois Rivières and Churchill (seasonal)

## **Section 3 Waste Treatment and Control**



### 3.1 Waste Management Facility

The location of the Waste Management Facility (WMF) is northeast of the main plant site.



The WMF is located on a parcel of land, approximately 895 by 1,535 feet in size that is owned by Vale. Within this area, the landfill cell #1 footprint covers an area of 265 by 630 feet at the south end of the WMF. The main building and storage shed are located on the southwest side of the WMF. The burn area and leachate holding pond are located on the north end of the site.

The nearest residence is roughly 1.5 miles away; thus the site is sufficiently separated so that no objectionable odours or noise are apparent to the neighbours.

The annual precipitation is 20 inches with the annual rainfall being 13 inches. It is expected that there will not be excess surface water as the total annual evaporation rate is 22 inches.

#### Components Of The WMF

**The primary components of the WMF include:**

- gated access road to provide controlled access into the WMF;
- waste disposal areas in defined landfill cells;
- main waste handling building;
- cold storage shed;
- outdoor storage pad;
- storage area for clean wood (burn area);
- leachate holding pond;
- expansion areas set up for future cell construction; and
- storage areas for cover soil;

- Groundwater table monitor wells for monitoring of the elevation and quality of groundwater within the WMF boundary.

### **Accepted Waste**

Only waste generated at or during work performed for Vale Manitoba Operations shall be accepted at the WMF.

Only industrial waste and solid waste as defined in Section 1 of the Waste Disposal Grounds Regulation 150/91, excluding any waste included in section 4.2 Prohibited Waste shall be disposed at the landfill tipping face.

### **Prohibited Waste**

The following wastes are prohibited from final disposal in the landfill cell at the WMF:

- hazardous wastes;
- radioactive materials;
- burning wastes (materials that are still at elevated temperatures);
- contaminated soil;
- liquids (as defined in Section 1 of the Waste Disposal Grounds Regulation 150/91);
- dead animals; and
- Explosives or ammunition.

### **Temporary Storage Of Waste**

**The WMF will also be used to temporarily store waste generated from Vale Manitoba Operations, including the following:**

- non-industrial recyclables (non-industrial plastics, recyclables, cardboard and office paper) – baled and, stored in the storage shed, and transported off site for recycling;
- industrial plastics – stored in the storage shed, and transported off site for disposal;
- wood – stored within the WMF and burned for disposal with a portion of the wood recovered for re-use;
- Contaminated – the waste oil will be pumped into the AST adjacent to the main building. Other contaminated material will be stored within the WMF. The contaminated waste will be transported off site for disposal; and
- hazardous - stored within the WMF, and transported off site for disposal

### **SLAM Dunk Program**

The intent of the SLAM Dunk Program is to promote sustainability, facilitate making the right choices by everyone, and not hinder Vale Manitoba operations.

It is believed that with changes in society toward a more conscientious attitude toward the environment, most people will choose to properly dispose of any waste given the opportunity.

Every Vale employee, contractor and visitor is equally responsible to “SLAM Dunk”.

The rationale behind the program is Reducing, Reusing and Recycling keeps waste out of the landfill, which is good for the environment. Coupled with this, the new Waste

Management Facility (WMF) has been designed with five landfill cells. If the SLAM Dunk program did not exist, the five cells would last 30 years. With good SLAM Dunk practices, one cell is expected to last 30 years.

Vale Manitoba Standard Procedure Instruction (SPI) segregates the waste into six streams namely:

- Scrap Metal
- Wood
- General recyclables
- Hazardous
- General Waste
- Cardboard

SLAM Dunk calls for further segregation of the main streams:

- Office Paper
- Industrial Plastic
- Non-Industrial Plastic
- Rubber
- Organic
- And those that do not fall into the above

In order to help everyone make the right choice Waste Bins are available in various styles through which waste streams are identified by colour, symbol and name.

When bins are found to contain mixed waste, a Correction Notice is issued. The Notices will indicate the bin type, the mixed waste type and how to properly handle the waste.

These notices along with requiring action by the department to correct the mixed waste situation are used as a training tool within the operation.

### **Old Landfill (South Yard)**

There is an in-active solid waste landfill site on the Thompson Mine site. It is located south east of the slag dump. At periodic intervals the accumulated garbage was buried under a layer of selected waste rock. Consequently each lift has been buried as the landfill evolved.

### **Used Tire/Rubber Waste Storage**

Used tires are currently being stockpiled within a designated area within the open pit waste rock dumps. Vale ships the accumulated inventory of tires and rubber off-site for recycling

on a regular basis. It is planned that the accumulated inventory of used tires will be shipped off-site for appropriate disposal prior to the date of permanent mine closure.

### **Soil Farm**

On the Thompson Mine site there is a designated area set up for bio-treatment of soils contaminated by hydrocarbons (south west corner of the tailings basin). Soils contaminated by hydrocarbon products, antifreeze and other chemical agents spilled on site are excavated and moved to this location for remediation using bacterial enhanced soil farming techniques. Clean sand or other suitable fill is brought in to backfill the areas from where contaminated soil has been removed.

Future plans have a soil farm being created within the WMF. The area under consideration is the space designated for Cell #5.

### **Asbestos Dump**

Asbestos is a substance regulated under Workplace Safety and Health (WSH) Regulation M.R. 217/2006 Part 37 – Asbestos. In accordance with Vale's SPI #36-5, The Use and Handling of Manufactured Asbestos, all asbestos waste including disposable coveralls, gloves, respirator cartridges, filters and material collected by the vacuum must be sealed in 10-mil polyethylene bags or wrapped with polyethylene. All bagged or wrapped material must be tagged as asbestos waste and stored in a designated location within the originating area, where it will not be disturbed until it can be transported to the on-Site asbestos waste landfill. The asbestos waste must be unloaded into an active area in the on-Site asbestos waste landfill for immediate burial and cannot be stockpiled adjacent to the landfill for burial at a later date. In accordance with Vale's Waste Disposal Ground Operating Permit No. 35818, when the asbestos waste has been placed in the on-Site landfill, an initial layer of cover material or fill (20 to 25 centimetres) should be placed over the asbestos waste before heavy equipment passes over the packages. The asbestos waste must be covered with approximately 2 meters of fill by the end of the working day. If the asbestos waste is placed in an active area of the on-Site asbestos landfill, up to 50 percent of the fill may consist of refuse.

### **PCB Storage**

The storage of PCB waste is regulated by M.R. 474/88 and by Environment Canada PCB Regulation SOR 2008/273 under the Canadian Environmental Protection Act, 1999, as amended. Vale has a permanent licensed storage facility located in the South Yard. PCB material is inventoried and placed in appropriate containers for disposal at a later date.

Future plans will have the PCB storage relocated to the WMF

### **Hazardous Waste**

Hazardous waste storage is located at the WMF Cold Storage Shed. Hazardous materials are collected from the designated areas within the Manitoba Operations Plant Site and

transported to the WMF where it is weighed and inventoried. Hazardous Materials at point of pickup are segregated and packaged according to TDG requirements. There is a designated area within the Storage shed for placement of Hazardous Waste complete with signage and physical barriers.

### **Refinery Burnables**

There is a designated area adjacent to the Old land fill site which is used for burning refinery contaminated wood. The contaminated wood is segregated from the clean wood and burned on a regular basis (controlled burn). The resulting ash is collected and consumed in the smelter

### **Clean Burnables**

There is a designated area within the WMF for the burning of clean wood based products. Clean combustible wood waste is typically segregated and periodically burned in a controlled manner, with the ash being incorporated into the landfill.

### **Waste Rock Pile**

Waste rock is collected in an area between the open pit and basin #1 of the TMA. Most of the oversized waste rock is from the open pit operations. The waste rock fines are a by-product of the rock crushing operations located in the waste rock area.

### **Concrete**

Waste concrete is deposited in designated areas of the waste rock pile.

### **Radio Active Storage**

A secure (locked) storage area exists on site for the storage of radioactive sources. These sources are primarily used in instrumentation devices within the Mill, Smelter and Refinery processes. The devices when not mounted in the field are stored in the facility which is located in the Central Maintenance Shops building. The storage area is clearly labeled and controlled in accordance with the Canada Atomic Energy guidelines.

### **Scrap Metal Area**

A central area located in the "south yard" has been designated as the scrap metals laydown area. Scrap metals are brought to the area and separated into different piles based on metal type (Steel, Aluminum, Copper, and Stainless Steel). The Scrap metal disposal is handled on a tender basis where qualified scrap metal vendors come to site and collect, weigh and transport to the recycling facilities the various metals. This disposal occurs approximately every two years (subject to collected quantities and or sale price).



## 3.2 Tailings Management Area

### Description

The Manitoba Operations Tailings Management Area has been in operation since 1960, and is located approximately four kilometers east of the plant site. The tailings facility has an area of approximately 58 square kilometers. The overall drainage within the facility trends in a northeast direction. There are five basins that make up the system. There are four tailings dams, Dam A, A1, Diversion Channel and B that contain the tailings within the facility. There is one control structure called the Discharge Weir or Area 5 Weir. Water enters the facility from a number of sources and travels northeast to discharge at the weir.

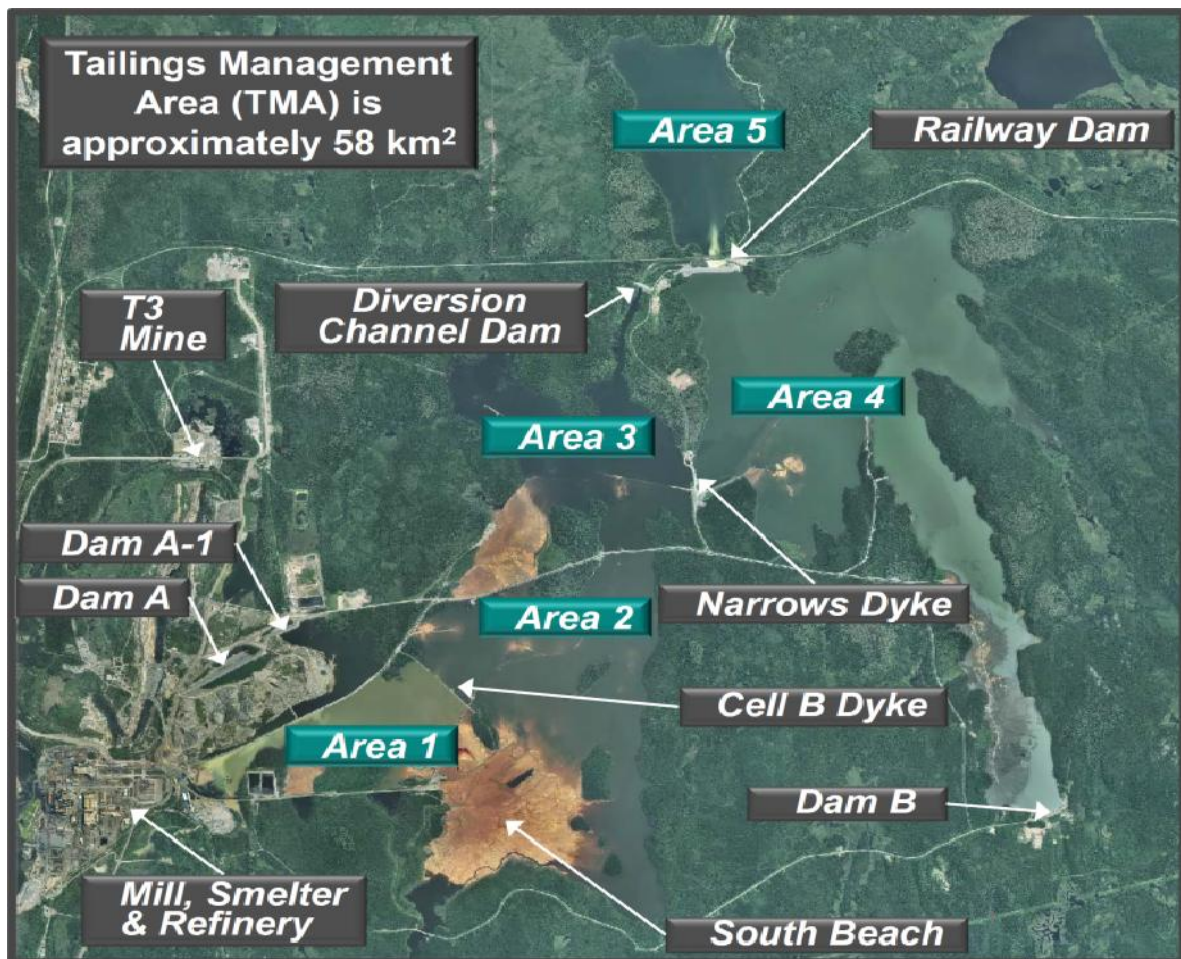

Over the life of the Operation there have been various mines in production including:

Thompson T1 Mine: 1959 - present  
Thompson T3 Mine: 1959 - present  
Birchtree Mine: 1966 - 1977 & 1989 - present  
Pipe Mine 2 Pit: 1969 - 1985  
Pipe Mine 1 Underground: 1970 - 1971  
Thompson Open Pit: 1985 - 1995, 2002 & 2006  
Soab North: 1969 - 1971  
Soab South: 1969 - 1971  
Moak: Exploration shaft only

## Water (hydrology and hydrogeology)

The catchment area of the tailings basin is approximately 45 km<sup>2</sup>. The basin is fed by the Grass River water system via marshy creeks at the south end of the Vale property. The discharge of the tailings facility flows through the weir structure and eventually meets up with the Burntwood River system through marshy creeks at the northeast end of the basin.

The water table in the catchment area is near the surface, varying between 1 meter in low laying areas and 13 meters where tailings have been deposited at the south west end of the tailings basin.

The flow leaving the catchment area is measured at the discharge weir at the northeast end of the tailings basin. Flows at the Area 5 Weir are typically 13,000 to 30,000 USGPM (50,000 to 200,000 cubic meters per day). Flow contributions from the plant site are as follows:

| Flow Source             | Flow USGPM                    |
|-------------------------|-------------------------------|
| Tailings Line Discharge | 6,500                         |
| 48" Sewer Discharge     | 2,300                         |
| Smelter Return Water    | 1,570                         |
| 42" inch Sewer          | 500                           |
| Pit Water (T1)          | 400<br>(estimated flow)       |
| Underground Mine Water  | 10 (0.02)<br>(estimated flow) |

Table 3.2.1 Flow Components – Plant Site Generated

The difference between the above flow sources and the total flow discharge through the weir is assumed to be from creeks and streams in originating in the surrounding areas, and from precipitation contributions.

There are fish-bearing streams both at south end of the tailings basin and past the weir structure in the northeast.

The natural pH of the tailings basin water and the surrounding streams and rivers averages 7.1.

## Geology and Geochemistry

The tailings facility is located on the boundary of between the Churchill & Superior Provinces in northern Manitoba. To the northwest, the region is in contact with para-gneisses of greywacke composition. To the southeast, the region is acidic and basic granulite facies containing granulite facies gabbros.

The bedrock of the tailings facility is comprised of archean gneisses, micaceous quartzite, skarn, schist, nickel mineralized schist, chert, iron formation and core rocks (thick assemblage of quartzites, schists & massive amphibolites).

The tailings facility is covered in varved clay of glacio-lucastrine origin. The varved clay is present in two distinct horizons; upper brown clay, which is weathered, desiccated and very stiff; along with a lower grey clay which becomes softer with depth. The varves consist of alternating high plastic clay and low to medium plastic silt or clayey silt. Organic clays and humus layer generally cover the varved clay deposits.



## Surrounding Land & Water Tenure & Use

Surrounding land is both Crown land and Local Government District of Mystery Lake land. Vale Limited removes water for both its own use and supplies the City of Thompson with its water needs from the Burntwood River system. The river passes alongside the city and continues on to meet the Nelson River system. Water from the tailings basin leaves the area from the discharge weir in the northeast and meets up with the Burntwood River system downstream from where water is removed for Vale and city use.

## Biological

There are a few species of fish within the tailings facility waters. These include perch, white sucker, minnows & sticklebacks. There is a resident smaller mammal population including shrews, deer mice, voles, red squirrel hares, fox, beaver & weasels. Larger mammals such as bears, wolverines and moose occasionally venture into the tailings facility areas.

Canada Geese, ducks, hawks, eagles, seagulls and an assortment of shore birds utilize the surrounding marshes for nesting.

## Facility Components

| Component         | Description   | Details   | Date of Construction         | Location  |
|-------------------|---|---|------------------------------|---|
| Dams              | A, A1   | Clay core, slag shell. Raising of Dam A1 was completed in 2012.                               | 1971-2                       | Dwg 85-447-C-05887  |
| Dam               | B   | Clay core, slag shell with 6-8" rock topping  | 1972                         | Dwg 85-447-C-05887  |
| Dam               | CN  | Clay core, slag shell with slurry wall. Phase 1 is currently completed.                       | 2013                         | CN Railway Crossing Area  |
| Tailings Beach    | Beach in Basin 1  | Exposed tailings 13m above current water levels, 2.7M m <sup>3</sup> in volume.               | Historical deposition method | South end of Basin 1  |
| Ditch             | Area 4 By pass ditch, Suez Canal                            | Man-made ditches dug in soil to control water flow in tailings basin.                         | 1991                         | By pass ditch located in the north end of Basin 3, Suez canal located north end of Basin 2. |
| Culverts          | East dredge, CN Dam, Dredge, Suez Canal, 48" sewer, Basin 1 | 42" steel pipe  |                              | As marked on attached drawings  |
| Bridge            | CN Spillway   | Concrete Structure with stop logs to control basin level.                                     | 2012                         | CN Railway Crossing Area  |
| Control Structure | Misery Lake Weir  | Concrete base with natural rock. All water released from tailings basin passes over the Weir. | 1971                         | Dwg 85-447-C-05887  |

|                    |   |   |  |  |
|--------------------|---|---|--|--|
| Control Structure  | Narrows Dyke  | Clay with 6" – 8" Rock equipped with large water control valve used to control the flow of water between areas 3 and 4  |  |  |
| Control Structures | Diversion Dam   | Clay Core + 6" – 8" Rock  |  |  |
| Control Structures | Clay berms at Basin 4 Bypass ditch  | 2 clay berms prevent flow through By-pass ditch.  |  |  |
| Tailings Pipeline  | 22" Steel<br>22" HDPE DR 9<br>22" HDPE DR 11<br>20" HDPE DR 17  | Steel Pipe exits the Mill and connects to DR 9 that runs to Area 1<br>DR11 runs throughout areas 1 to 3 and then reduces to a 20" DR 17 pipe in Area 4  |  |  |
| Pumps              | Mill Tailings Pumps   | Also known as D2 Pumps include 2 sets called 1A & B and 2 A & B   |  |  |
| Valves and Drains  | Vacuum Breaks<br>1 – Area 1<br>1 – Area 2<br>1 – Area 3<br>1 – Narrows Turn-off<br>1 – "Y" Winter Road<br>1 – Area 4<br><br>Drain Back Valves<br>5 – Area 1<br>2 – Area 2<br>2 – Area 3<br>2 – Main Road<br>1 – Winter Road<br>1 – Area 4 | All drains are T's in the pipeline with a manual valve. The vacuum break allows pressure release during drainage. Drain back in the mill allows the trestle to drain back into the mill to prevent sanding. |  |  |
| Pipeline Bridges   | Trestle   | Steel / HDPE pipe runs along trestle from mill to Basin 1.  |  |  |
| Pipeline Crossings | Causeway Access Road, Narrows Road  | 42" culvert & other water culverts  |  |  |
| Impoundment Areas  | T3 Sewage Lagoon  | Excavated in soil, lined with clay, overflow is directed into Basin 3   |  |  |
| Sewers             | 48", 42" and the 1D de-watering pipe  | 48" and the 42" sewer collects process water and run off from the plant site and directs it into Basin 1. The 1D mine water is pumped from underground and directed into the basin West Side of Basin 3.    |  |  |

Table 3.2.2 Tailings and Water Management Components

| Component | Description  | Details  | Location                               |
|-----------|--|--|--|
| Roads     | Dam B access, Pipeline Road, Causeway Road, CN Dam Road, Dam A Road, Cell B Road, Weir Road, Area 2 Road, New Dam B Road   | Built on top of previously deposited tailings or land. 6" mine waste used for construction. Geotech fabric is placed between tailings and waste rock during summer months. Roads are graded with -3/4" fill. | Various locations throughout the basin |
| Railroads | CN Railway Line  | Maintained by CN   | 85-447-C-0543,44,45                    |
| Signage   | Dam B access road, South tailings basin road @ Asbestos dump, Dredge pipe road at old booster station, Below dam, (south side), <i>at rail line at North end of basin four</i> | 4' x 6', White & Red<br>WARNING<br>MILL TAILINGS BASIN<br>AUTHORIZED<br>PERSONNEL ONLY   |  |

Table 3.2.3 Facility Components – Infrastructure

| Component             | Description  | Details  | Location  |
|-----------------------|--|--|---|
| Piezometers           | Piezometers installed in the following locations: Dam A, Dam A1, Dam B, Railway Dam    | Dam A – 5 Piezometers<br>Dam A1 – 1 piezometer<br>Dam B – 17 piezometers<br>Railway Dam – 7 piezometers  | All Dams  |
| Weirs                 | V-Notch Weir at Dam B, Basin 5 Weir  |  |   |
| Inclinometers         | Installed in the following locations: Dam A, Dam A1, Dam B, Railway Dam, Diversion Dam | Dam A – 3 Slope Inclinometer<br>Dam A1 – 1 Slope Inclinometer<br>Dam B – 25 Alignment Pins<br>Railway Dam – 5 Slope Inclinometer<br>Diversion Dam – 9 Alignment Pins | All Dams  |
| Computerized Controls | D2 PLC, Mill ABB DCS system  | Controls operation of the tailings pumps, freeze protection and lime control   | Mill  |
| Pump monitoring       | Vibration analysis, speed, motor amp, temperature and discharge pressure measurements  | Instrumentation located on pumps to monitor performance  | Mill  |
| Pipeline Monitoring   | Flowmeter and pressure meters  | To measure flow in pipeline to control pump speed and prevent sanding of line.   | Mill  |
| pH control            | 48" sewer and D2 pump discharge  | To control lime addition to the tailings basin facility  | Mill and various locations throughout the basin |

Table 3.2.4 Facility Components – Instrumentation

## Regulatory Reporting

The Manitoba Operations Environment Department obtains samples at various locations of the tailings basin on a weekly basis. In operating the tailings facility, only the discharge weir sample result is reported weekly to both provincial and federal levels of government.

## Facility Operation

The tailings are delivered by means of a single pump in the mill and a 20 inch diameter pipeline that is over 8.5 km long. Approximately 2,000 to 6,500 USGM of fresh water is used to pump the tailings as low density slurry (about 10% solids). The tailings line is advanced into the area of deposition along roads constructed on top of previously deposited tailings. As a result, some of the tailings are exposed above water in association with the road construction. If the water level drops after the road is constructed, then more of the deposited tailings become exposed. The tailings basin water elevation is currently maintained at 672 feet in areas 1 – 3 and 668 feet in area 4.

The existing tailings delivery pipeline system is approximately 9 to 10 km in length. There is a 22 inch carbon steel pipe coming out of the building that is connected to the 22 inch HDPE pipe. The pipeline extends from the mill to the discharge point in Area 4.

Tailings are deposited via the 20 inch line at a rate of about 7,000 USGPM with a solids content of 0.93 to 1 ton/yd<sup>3</sup> and average solids specific gravity of 2.8.

The mill tailings stream consists of the gangue material not recovered in the flotation process. The coarse portion of the scavenger tailings stream is removed for underground sand fill for within Thompson Mine. The remainder of the mill tailings product is pumped to the tailings basin. The tailings flow represents approximately 75% by weight of the mill feed. The tailings are pumped to the tailings basin between 7-11% solids (measured by weight) and deposited subaqueously.

The typical size distributions for Thompson Mill Tailings are shown in Table . The size distribution varies if the sandplant is operational. When the sand plant is operating the coarse (sand) fraction of the tailings stream is removed by hydro-cyclones. The sand plant operates for approximately 30-40% of the mill operating time.

| Size fraction | With Sandplant (Wt % retained) | Without Sandplant (Wt % retained) |
|---------------|--------------------------------|-----------------------------------|
| +300 µm       | 3.2                            | 4.2                               |
| +212 µm       | 5.3                            | 11.8                              |
| +150 µm       | 7.9                            | 13.6                              |
| +75 µm        | 22.8                           | 30.0                              |
| +44 µm        | 26.8                           | 17.4                              |
| -44 µm        | 34.0                           | 23.0                              |

Table 3.2.5 Grain Size Distribution of Tailings Solids

The tailings mineralogy is made up of sulphide and gangue rock. The sulphide portion is mostly iron sulphide in the form of pyrrhotite with trace chalcopyrite and pentlandite. The rock component is made up of major quartz, chlorite, serpentine, feldspar, biotite with minor or trace talc, amphiboles and chromite. The approximate percentages and ranges are listed below in Table . The dry specific gravity of the tailings stream is 2.7 to 2.9 with 2.8 being used for average calculations.

|              | Minimum (%) | Nominal (%) | Maximum (%) |
|--------------|-------------|-------------|-------------|
| Pentlandite  | 0.4         | 0.6         | 0.8         |
| Chalcopyrite | 0.03        | 0.05        | 0.10        |
| Pyrrhotite   | 10          | 16.3        | 25          |
| Rock*        | 73          | 83          | 89          |

Table 3.2.6 Mineralogy of Tailings Stream

\*Comprising a variety of silicates and oxide minerals listed above.

The slurry is discharged at the end of the pipeline into the basin over a waste rock berm. After the tailings fill in the underwater area ahead of the tailings discharge pipe, the pipeline is extended by building a waste rock road and then connecting a new piece of pipe.

Lime is added to the tailings stream to control the pH in the tailings basin. Dry lime is slaked in the mill and lime slurry is pumped into the tailings sump. A pH reading in the tailings sump controls the lime addition. The pH is controlled based on the weekly water quality results.

### 3.3 Water Management Flow

#### Tailings Facility Water Inputs

The Tailings basin naturally flows from south to north. Discharging into the environment over a rockfill weir built in 2009, located at and incorporating the old Area 5 concrete weir, at the far north end of Basin 5 (Misery Lake). Several different effluents enter the basin: Tailings Line Discharge, 48 inch sewer, 42 inch sewer, Pit water, T-3 underground mine water and natural drainage and run-off. All have specific locations of entry to the basin but all share one exit at the weir.

#### Mill Tailings Discharge

The Thompson Mill Tailings Pump is the single largest source of water entering the tailings system. This process stream is made up of mill tailings, sump make-up water, crushing water, smelter thickener overflow water and mine dirty water. These are all combined into the sump and pumped to the basin. Lime is added to precipitate any soluble nickel and adjust the pH in the tailings basin.

#### 1D Mine Dewatering Drainage

All water from mining operations at T3 flows to the lowest part of the 1D operation and is pumped to the west end of basin 3. From The west end of basin 3 it is able to flow around the north side of basin 3 into basin 4 and out to the weir.

48" and 42" Sewer

The 42" and 48" sewers effluent contains natural run off, process water and biological wastes from the plant site. Lime is added to precipitate any soluble nickel.

**Reference: Appendix 3 Station B, Weir and BT Effluent Discharge results for 2014**

**Appendix 4 42" and 48" Sewer Schematic**

## Waste Water Flow

The figure above shows Manitoba Operations water macro-flow (all-site flow) diagram, comprising both Thompson Operation and Birchtree Mine. The diagram indicates the flow lines where measurements are available, as well as those lines where measurements are estimated and also those where neither measurements nor estimates exist, but nevertheless are needed for a reasonable quantification of the water flow.

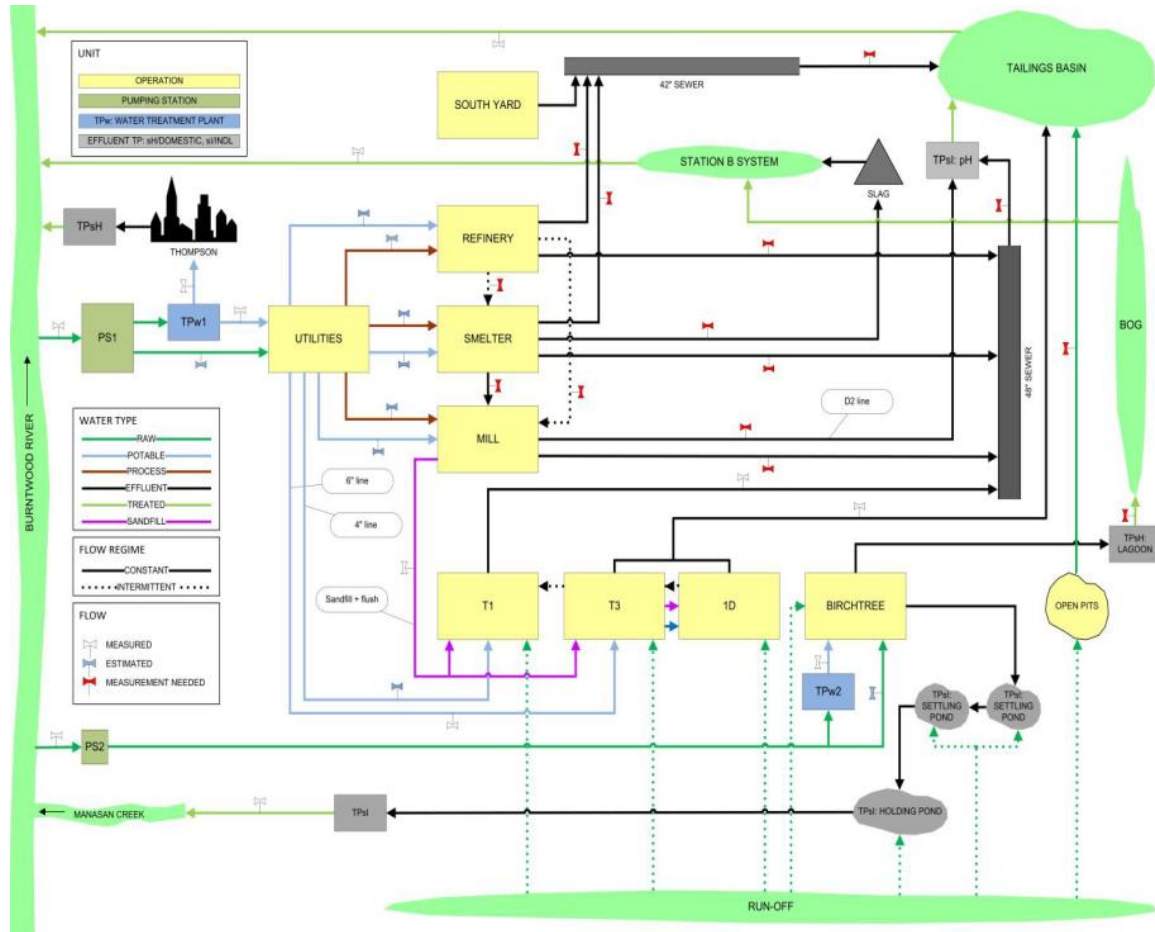

Thompson Operation is supplied with water withdrawn from Burntwood River at PS1 diversion point situated on the right bank of the river. Diversion and pumping are under the responsibility of the Utilities, which treats a part of the diverted flow and distributes both potable and process water to all facilities.

Part of the water withdrawn from Burntwood River is pumped at PS1 to TPw1 main water treatment plant while another part is pumped in raw state to the Utilities. At TPw1, approximately 62% of the treated volume is supplied as potable (drinking) water to the City of Thompson, while the remaining 38% are pumped to the Utilities. This facility utilizes part of the potable water for its own use, for instance, for human consumption and for the production of steam for heating of all facilities. Both potable and raw water are distributed to the Mill, the Smelter, the Refinery, and to T1 and T3/1D Mines. Raw water is distributed by the Utilities as process water.

On the other hand, Birchtree Mine, is supplied with water from PS2 diversion point, also situated on the right bank of the Burntwood River. Birchtree is responsible for both water diversion and treatment (at TPw2) for its own operational purposes.

Since 2011 Vale has been working to reduce its water consumption via system upgrades and improved water management practices.



### **3.4 Emissions and Air Quality Programs Overview**

Through the Atmospheric Emissions Reduction (AER) Program, Vale conducts research and development, engineering studies, pilot programs and capital projects aimed at reducing emissions of substances, primarily particulate and SO<sub>2</sub>. The program takes into account the annual (Federal) limit targets and Base Metals Sector Environmental Code of Practice recommendations established by Environment Canada.

Vale Manitoba Operations' Community Air Quality Protection Program (CAPP):

#### **Voluntary Emissions Reduction Program (VERP)**

The Thompson Voluntary Emissions Reduction Program (VERP) is an initiative designed by Vale Manitoba Operations to reduce downwind ground level Sulphur Dioxide (SO<sub>2</sub>) emissions into the City of Thompson, while still enabling the production of nickel in a cost effective manner.

The program's goals are to predict meteorological conditions for the day, monitor for changes in weather and ambient SO<sub>2</sub> concentrations, adjust smelter emissions to match prevailing meteorological conditions, and compensate with changes to smelter operations to ensure compliance with Manitoba Regulation 165/88, Vale Limited and Hudson Bay Mining Co. Limited Smelter Complex Regulation (C.C.S.M. c. E125) (Government of Manitoba); as well as to meet the Guideline for Ambient Air Quality: Sulphur Dioxide (Canadian Ministers of the Environment, adopted by Manitoba Conservation). See Table 1

Short range dispersion modelling, National Air Pollution Surveillance Network citing criteria, community input and consultation with the Government of Manitoba were used to locate the four (4) ambient SO<sub>2</sub> monitoring stations within the community of Thompson.

#### **Air Quality Forecasting Tool**

SENES Consulting developed a FreSH Air forecasting system for the Manitoba Operations (implemented in 2005) which is a fully functional stand-alone air quality forecasting tool. It combines the strength of the FReSH-4 Weather Forecasting System with a fully three-dimensional state-of-the-art air pollution dispersion modeling system (CALPUFF). The output from the programs provides a 24, 48 and 72 hour prediction of ambient SO<sub>2</sub> concentrations in each of the four community areas represented by the monitoring stations and for each of the 24 possible operating configurations that can be run by the Thompson Smelter.

#### **Environmental Information System (EIS)**

The smelter control room is also equipped with an Environmental Information System (EIS), which provides a continuous display of SO<sub>2</sub> levels and weather conditions, and features audible warning alarms and system diagnostics. Under certain weather dispersion conditions, the City of Thompson may be exposed to emissions from the smelter stack. The smelter control room operator will manage the smelter operation and work in accordance with the smelter VERP protocol, by shutting production units down, in a safe and orderly succession, to control ground level concentrations from the smelter stack.

## **Community Engagement**

The Manitoba Operations routinely engages with communities of interest through the Vale Community Liaison Committee, where representatives from the region can raise questions or concerns about matters such as air quality. In addition, a 24 hour Environmental Hotline is maintained to allow the public to communicate concerns about air quality at any time. The Vale Manitoba Operations Smelter provides a mobile monitoring unit that can be dispatched to investigate community SO<sub>2</sub> concerns, to monitor plume conditions or to determine ambient SO<sub>2</sub> readings where there is no fixed station monitoring.

## **Particulate Monitoring**

A monitoring program is in place for total suspended particulate, PM<sub>10</sub>, PM<sub>2.5</sub> and metals in ambient air, as part of a Memorandum of Understanding (MOU) with Manitoba Conservation that was signed in 2004. One station monitors PM<sub>10</sub> and PM<sub>2.5</sub> in real time (TEOM) and the other station collects samples of particulate every 3 days for metals analysis (Partisol). These particulate matter monitoring results are assessed against the Canadian Ambient Air Quality Guidelines.

Vale Manitoba Operations' Emissions Monitoring Program:

## **Smelter Stack Sampling**

Pursuant to Manitoba Regulation 165/88 Vale Limited and Hudson Bay Mining Co. Limited Smelter Complex Regulation (C.C.S.M. c. E125); emissions of substances in Particulate Matter (PM) from the Smelter Stack are tested at least every 3 years in accordance with Manitoba Stack Sampling Protocols.

To ensure compliance with reporting requirements under the Canadian Environmental Protection Act, 1999, and to assess performance of Vale's Environmental Programs (Pollution Prevention Plan, Implementation of the BMS Environmental Code of Practice, CCME Canada-Wide Standards) substances in PM routinely tested for include Criteria Air Contaminants, Metals, Mercury, Dioxins and Furans, and the determination of PM size distribution (PM<sub>2.5</sub> & PM<sub>10</sub>)

## **Continuous Particulate Emission Monitoring**

Also pursuant to Manitoba Regulation 165/88, and in accordance with proposed Performance Agreements between Vale of Canada Limited and the Government of Canada, emissions of PM from the smelter stack are monitored continuously and emissions of SO<sub>2</sub> are determined through a Sulphur Mass Balance.

Vale's continuous emission monitoring system (CEMS) is located at the stack breach where total stack gas flow and particulate emissions are measured. The P5B mass emission monitor (CEMS) provides continuous, in-situ, measurement of particulate mass emissions entrained in a gas stream. In 2011 a comprehensive quality control program was implemented (approved by the Government of Manitoba) for the Thompson Smelter Stack CEM; the QA/QC program conforms to the United States Environmental Protection Agency CEM Performance Evaluation Assessment Methodology

## Determination of SO<sub>2</sub> Emissions

The Sulphur mass balance calculates total Sulphur emitted, as Sulphur in inputs minus Sulphur fixed in product and waste streams. All S that is not fixed in product or wastes is assumed emitted as SO<sub>2</sub>. Thus, the calculated emission includes both process and fugitive SO<sub>2</sub>. The S mass balance program utilizes material balances determined by truck and railcar shipping weights, and determination of Sulphur by the LECO analytical method, performed by the Vale Manitoba Division laboratory which is ISO-IEC 17025 certified by the American Association for Laboratory Accreditation.

## Other Emission Sources

Emissions from the Thompson Nickel Refinery are source tested, at minimum, every 5 years. Site specific emission factors have been developed for the 13 Nickel Refinery point sources to determine annual emissions of Chlorine, SO<sub>2</sub>, PM and Metals in PM.

Site specific emission factors are also applied to the determination of annual emissions of PM & PM size distribution (PM<sub>2.5</sub> & PM<sub>10</sub>) from the Thompson Mill and the Thompson T1, T3 and Birchtree Mine Ventilation systems. Fugitive emissions originating from unpaved road dust are estimated in accordance with sector specific guidance from Environment Canada for reporting to the National Pollutant Release Inventory (a requirement under CEPA, 1999).

## Vale Manitoba Operation's Environmental Effects Monitoring

Long term environmental effects of smelting emissions are monitored periodically. Key environmental indicators (air quality, soils, vegetation, terrestrial wildlife, water quality, aquatic environment and landscape) at specific study locations are monitored to determine if there has been an increase or decrease in environmental effects over a 20 year period of time.

Most recently, between 2004 & 2006, Vale Manitoba Operations undertook a comprehensive environmental effects monitoring (EEM) study to determine changes in the effects since the last EEM study conducted in 1981. This study also examined the sensitivity of Manitoba lakes in the Thompson region and surrounding areas to acidifying compounds to establish whether these lakes may be susceptible to acidification from SO<sub>2</sub> emissions. A spatial assessment of the sensitivity of these lakes was evaluated through the determination of lake buffering capacity and a comparison of lake water pH and Sulphate concentrations in relation to the Thompson smelter. The study also described the relationships between lake chemistry and other characteristics, such as bedrock geology.

| Table 1 Guidelines - Sulphur Dioxide in Ambient Air |                  |                               |                    |      |
|---|------------------|-------------------------------|--------------------|------|
| Agency  | Averaging Period | Limit Value (units are ug/m3) | Note               | PPM  |
| Canadian Environmental Quality Guideline            | 1-hour           | 900                           | Maximum Acceptable | 0.34 |

**Reference: Appendix 5 2014 NPRI substance and GHG reports**

## **Section 4 Decommissioned/Inactive Sites**

#### **4.1 Moak Lake (Decommissioned)**

Moak Lake is located approximately 45 Kilometers north east of Thompson. Surface drilling began in early 1950's. In 1954 work commenced on an exploration shaft (6' x 16') which was sunk to a depth of 1324 feet. A second shaft was raised from 1300 foot level to the 700 foot level and from 700 feet to surface in two lifts. This Shaft was 7' x 11'.

A campsite was constructed about two kilometres from the mine site and comprised of several structures including cottage style family dwellings, bunk houses and a camp kitchen/mess hall.

In 1958 Work at Moak mine was suspended as a result of the findings at the current Thompson site. In 1973 the head frame was removed and both shafts were capped with concrete and the mine workings were allowed to flood.

Currently the site has been fully restored to its original condition. A fence is installed around the shaft area for security and safety reasons. Permanent plaques are mounted on the caps of both shafts.

In 1978 the Moak Lake Camp site was turned over to the Thompson Rotary Club. The buildings were renovated and the facility is operated as a summer camp for Thompson and area youth. In 1992 the stewardship of the facility was transferred to the Ma-Mow-We-Tak Friendship Centre.

#### **4.2 SOAB North (Decommissioned)**

The Soab North Mine was located in northern Manitoba, approximately 67 km south of the city of Thompson. The mine produced approximately 365,000 tons of nickel ore from an underground sulphide orebody from 1969 to 1971 before mining operations were suspended and the mine became inactive. The ore was shipped by truck to an ore receiving building at Vale's (Inco's) Soab South Mine and hauled by rail cars via Vale's (Inco's) Soab-Thompson rail line for processing at Vale (Inco's) Thompson Mill, Smelter and Refinery complex.

Soab North Mine was first discovered in 1953 in what was a native boreal forest. Since that time, the surrounding areas have been used for mining-related activities. The mine became inactive after being shut down in 1971.

In 1998 the surface buildings and headframe were removed from the site as part of a progressive decommissioning plan. Concrete pads and pony walls are the remnants of the surface buildings. The mine-site, shaft facilities, and plant and equipment were maintained on a standby basis from the suspension of production operations in 1971 until 1982. In 1982 major underground stationary equipment was removed, including mine dewatering pumps. At that time, the openings to the underground mine were capped and sealed and the mine was allowed to flood.

The current situation has the site fully rehabilitated with continued effluent and physical stability monitoring.

### **4.3 SOAB South (Decommissioned)**

The Soab South Mine was located in northern Manitoba, approximately 70 km south of the city of Thompson. The mine produced 580,000 tons of nickel ore from an underground sulphide orebody from 1969 to 1971 before mining operations were suspended and the mine became inactive. The ore was hauled by rail cars via Vale (Inco's) Soab-Thompson rail line for processing at Vale (Inco's) Thompson Mill, Smelter and Refinery complex.

Soab South Mine closure area was first discovered in 1953 in what was a native boreal forest. Since that time, the surrounding areas have been used for mining-related activities. The mine became inactive, after being shut down in 1971. The mine-site, shaft facilities, plant and equipment were maintained on a standby basis by Vale (Inco), from the suspension of production operations in 1971 until 1982. In 1982 major underground stationary equipment was removed, including mine dewatering pumps. At that time the openings to the underground mine were capped and sealed and the mine was allowed to flood.

The current situation has the site fully rehabilitated with continued effluent and physical stability monitoring.

### **4.4 Pipe Mine (Care and Maintenance)**

The Pipe Mine (Pipe No. 1 Mine and Pipe No. 2 Mine) is located in northern Manitoba, approximately 35 km south-west of the City of Thompson, in the Mystery Lake District. Pipe No. 1 Mine produced approximately 280,000 tons of nickel ore from an underground sulphide orebody from 1970 to 1971 before mining operations were suspended and the mine became inactive. Pipe No. 2 Mine produced approximately 17.8 million tons of nickel ore from a surface open pit sulphide orebody from 1970 to 1984 before the mining operations were completed and the mine became inactive. Pipe No. 1 ore was shipped by truck to an ore receiving building at Vale (Inco's) Pipe No. 2 Mine Complex. Pipe No. 2 ore was hauled out of the open pit by trucks to a crusher before being conveyed to the ore receiving building at Vale (Inco's) Pipe No. 2 Mine Complex. The ore from both mines was hauled by rail cars via Vale (Inco's) Soab-Thompson rail line for processing at Vale (Inco's) Thompson Mill, Smelter and Refinery complex.

Pipe No. 1 Mine area was first discovered in 1957 in what was a native boreal forest. Since that time, the surrounding areas have been used for mining-related activities. Today, the mine is inactive, being shut down at the end of 1971 after being developed and mined by a mining contractor for Vale (Inco) Ltd over a 4 year period. The mining contractor maintained a small trailer court for his employee's during the development and operating period. All trailers were removed in 1972 after production was suspended at Pipe No. 1 Mine. Re-vegetation has occurred naturally at the trailer court site since that time.

The mine's shaft facilities, surface plant, and equipment were maintained on a standby basis by Vale (Inco) Limited from 1971 until 1982. In 1982 major underground stationary equipment was removed, including the mine dewatering pumps. At that time, the openings to the underground mine were capped and sealed and the mine was allowed to flood. Entrances to all buildings were sealed and access to the mine site by the general public was

restricted as the result of signage and a locked gate placed at the entrance of the yard to prevent entry to the mine site.

Surface features and facilities located in the vicinity of the Pipe No. 1 include the following:

- Hoist and Compressor Building
- Headframe and Collarhouse
- Small Shops Building
- Small Storage Buildings
- Fresh Air Raise Collar
- Mine Yard.

Pipe No. 2 Mine area was first discovered in 1957 in what was a native boreal forest. Since that time, the surrounding areas have been used for mining-related activities. Today, the mine site is inactive, having been shut down in 1985 after cessation of the mining of the open pit and subsequent underground exploration. The mine's 2 shafts have been capped, allowing the underground excavations and the open pit to flood. Vale (Inco) Limited is carrying out surface exploration and geophysical work in the closure area.

Entrances to all buildings were sealed and access to the site by the general public is restricted as the result of signage and a locked gate placed at the entrance of the main access road to the mine site.

Surface features and facilities located in the vicinity of the Pipe No.2 Mine include the following:

- Headframe
- Office and Dry Building
- Auxiliary Building (utilities, shops, warehouse)
- Air Intake Building
- Ore Terminal Building, Transfer House & Conveyors Galleries.
- Storage Buildings
- Sewage Treatment Plant
- Switchgear Room
- Gate House
- Taylor River Pump House
- Electrical Substation and Transmission Lines
- Mine Yard and Parking Lot
- Waste Rock Piles

The mine site is not fully decommissioned nor have closure activities fully commenced. Inspection and testing by Vale personnel of the facilities and water are undertaken on a regular basis.



## **Section 5 Appendices**

Appendix 1 - Thompson Site Plan

Appendix 2 - Operations Flow Sheet

Appendix 3 - Station B, Weir and BT Effluent Discharge results for 2014

Appendix 4 - 42" and 48" Sewer Schematic

Appendix 5 - 2014 NPRI substance & GHG reports